

# Ethernet-APL Rail Field Switch

## ARS12-B2-IC24-1



- Managed Ethernet-APL field switch for process industries
- Powered spur ports intrinsically safe Ex ic according to 2-WISE and FISCO
- PROFINET MRP, S2 redundancy and dynamic reconfiguration
- 2 ports each for 1000BASE-T and SFP transceivers
- Redundant power input 20 VDC ... 60 VDC
- Installation in Zone 2
- Physical layer diagnostics at the spur
- Configuration and diagnosis with FDI, web interface, PROFINET device functions and SNMP
- Support of network security

Ethernet-APL rail field switch with 24 intrinsically safe Ex ic spur ports and screw terminals



**ethernet-apl**<sup>™</sup>  
advanced physical layer



### Function

The Ethernet-APL rail field switch is a ruggedized, managed field switch offering connectivity for Ethernet-APL devices to Ethernet networks via any protocol. The connections, i. e., "spur" ports, provide intrinsically safe (Ex ic) power and communication to instruments located in Zone 2. APL field switches can be installed in Zone 2.

The APL field switch features 2 Gigabit Ethernet ports and 2 SFP ports. The SFP ports provide connections for a choice of optional SFP transceivers to be used in explosion-hazardous areas and different distances.

For PROFINET, the APL field switch supports Class B networks. For high-availability installations, the APL field switch provides redundancy mechanisms such as MRP ring redundancy and S2 system redundancy.

Easy configuration and diagnostics of the APL field switch are accessible via FDI and web-based management. PROFINET device functions and SNMP assure fast start-up and enable the use of predictive maintenance. Comprehensive network and physical layer diagnostics enable proactive management strategies to reduce risk of failure and downtime.

The APL field switch implements enhanced network security and supports SNMPv3, the locking of unused ports, and the HTTPS protocol.

# Function Principle

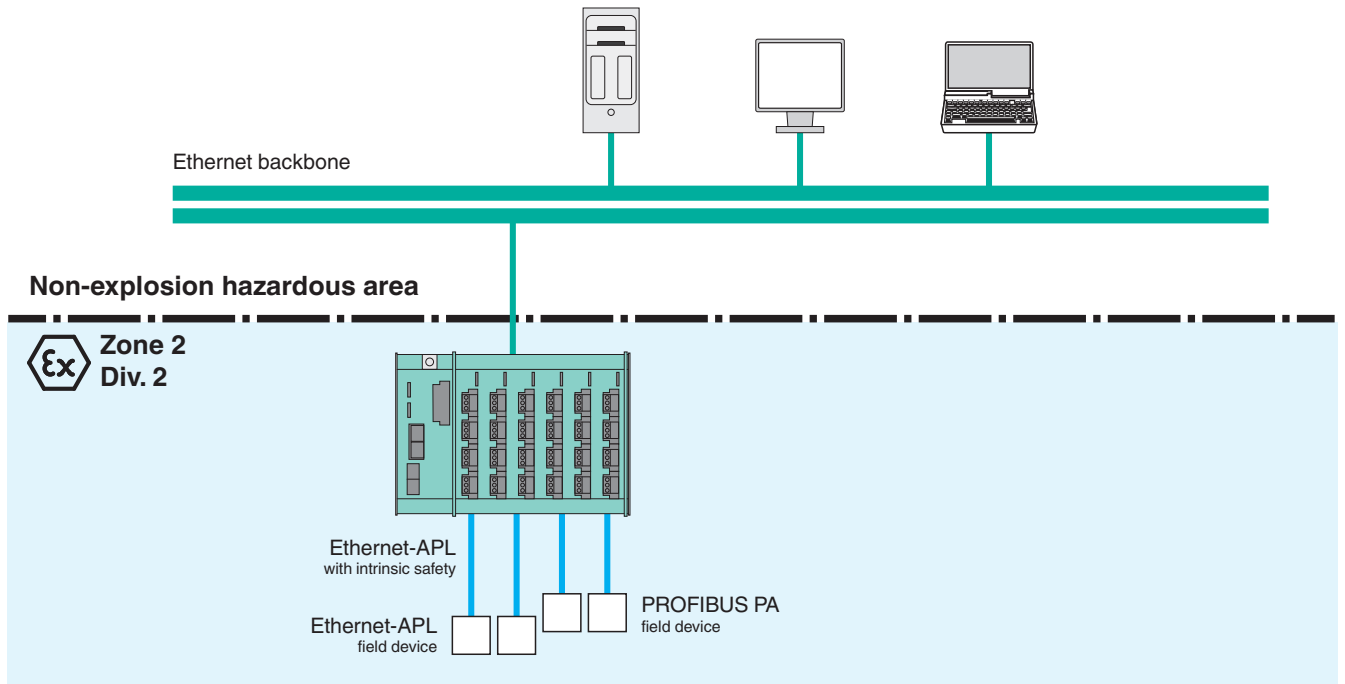

Release date: 2023-08-24 Date of issue: 2023-08-24 Filename: 70121859-100005\_eng.pdf

Refer to "General Notes Relating to Pepperl+Fuchs Product Information".

Pepperl+Fuchs Group  
www.pepperl-fuchs.com

USA: +1 330 486 0002  
pa-info@us.pepperl-fuchs.com

Germany: +49 621 776 2222  
pa-info@de.pepperl-fuchs.com

Singapore: +65 6779 9091  
pa-info@sg.pepperl-fuchs.com

**pf** PEPPERL+FUCHS

**Dimensions**

**DIN Rail Mounting**

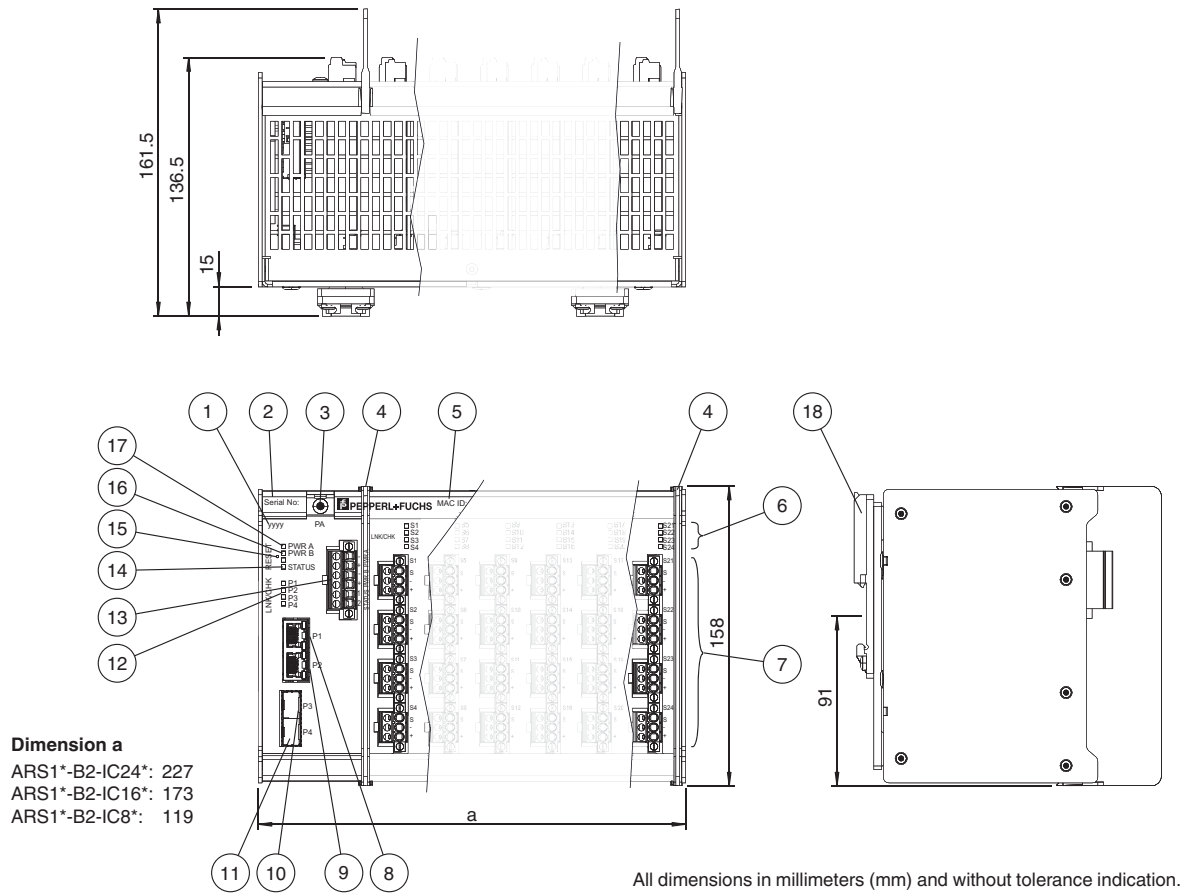

All dimensions in millimeters (mm) and without tolerance indication.

- 1 Year of production
- 2 Serial number
- 3 PA, connection to equipotential bonding
- 4 Slot for separation wall
- 5 MAC ID
- 6 LED S1 ... Sn, status spur ports S1 ... Sn
- 7 Connectors for intrinsically safe spurs S1 ... Sn
- 8 Ethernet port P1
- 9 Ethernet port P2
- 10 Ethernet SFP port P3
- 11 Ethernet SFP port P4
- 12 LED LNK/CHK P1 ... P4, communication status LED P1 ... P4
- 13 Connector for auxiliary power and status indication output
- 14 LED STATUS, status rail field switch
- 15 Reset button
- 16 LED PWR B, status power input B
- 17 LED PWR A, status power input A
- 18 DIN rail mounting brackets

**Technical Data**

<b>General specifications</b>			
Design / Mounting		Cabinet installation	
Fieldbus support		n/a	
<b>Supply</b>			
Rated voltage	U <sub>r</sub>	20 ... 60 V	
Rated current	I <sub>r</sub>	0.85 ... 2.55 A	
Power dissipation		26.7 W	
Voltage difference dual supply input		+/- 10 %	

Release date: 2023-08-24 Date of issue: 2023-08-24 Filename: 70121859-100005\_eng.pdf

Refer to "General Notes Relating to Pepperl+Fuchs Product Information".

## Technical Data

Power consumption	max. 51 W
Redundancy	dual supply input
<b>Indicators/operating means</b>	
LED PWR A/B	green: power on
LED LNK/CHK	Off: no communication link active , Green: communication link active , Green flashing: communication link activity , Red flashing: check function
LED STATUS	Off: Good , Blue: Maintenance required , Red: Failure
Fault signal	VFC alarm 100 mA, 32 V DC, normally closed
Button	Device reset
<b>Interface 1</b>	
Interface type	Ethernet-APL : 1 Vpp option spur connection
Port classification	S P C C
Number of ports	24
Port identification	S 1 ... S 24
Power option	powered
Transfer rate	10 MBit/s full duplex
Rated voltage	11.61 V
Rated current	95 mA
Rated power	1.11 W
Cable shield grounding option	capacitive grounded
Connection type	pluggable screw terminals
Conductor cross section solid wire	2.08 ... 0.326 mm <sup>2</sup> , 14 ... 18 AWG
Conductor cross section flexible wire	2.08 ... 0.326 mm <sup>2</sup> , 14 ... 18 AWG
<b>Interface 2</b>	
Interface type	1000BASE-T
Number of ports	2
Port identification	P 1 ... P 2
Transfer rate	10/100/1000 Mbps
Connection type	RJ-45 , EIA/TIA 568 B
<b>Interface 3</b>	
Interface type	Slot for SFP transceiver SFP Multi-Source (MSA) compliant
Number of ports	2
Port identification	P 3 ... P 4
<b>Galvanic isolation</b>	
Spurs/Supply	1500 V AC
SFP/Supply	500 V AC
1000BASE-T/Supply	1500 V AC
1000BASE-T/Spurs	1500 V AC
1000BASE-T/1000BASE-T	1500 V AC
Housing/All	620 V AC
Fault signal/All	1500 V AC
<b>Directive conformity</b>	
Electromagnetic compatibility	
Directive 2014/30/EU	EN 61326-1:2013
<b>Conformity</b>	
Galvanic isolation	IEC 61010-1
Electromagnetic compatibility	EN 61326 , NE 21
Degree of protection	IEC 60529
Ethernet	IEEE 802.3z , IEEE 802.3u , IEEE 802.3cg
Shock resistance	EN 60068-2-27

Release date: 2023-08-24 Date of issue: 2023-08-24 Filename: 70121859-100005\_eng.pdf

Refer to "General Notes Relating to Pepperl+Fuchs Product Information".

Pepperl+Fuchs Group  
www.pepperl-fuchs.com

USA: +1 330 486 0002  
pa-info@us.pepperl-fuchs.com

Germany: +49 621 776 2222  
pa-info@de.pepperl-fuchs.com

Singapore: +65 6779 9091  
pa-info@sg.pepperl-fuchs.com

 PEPPERL+FUCHS

## Technical Data

Vibration resistance	EN 60068-2-6	
Climatic conditions	DIN IEC 721	
<b>Software</b>		
Industrial protocols	PROFINET , CC-B (PA) , dynamic reconfiguration , Netload Class III , pruning	
Management	Web user interface , SNMP v1, v2 , v3 , PROFINET	
Redundancy	PROFINET MRP , PROFINET system redundancy S2	
Management Information Base (MIB)	PROFINET conformance class B	
Cybersecurity	HTTPS , Port locking , Protocol disabling , PROFINET security level 1	
Diagnostics function	10BASE-T1L physical layer , port , Packet statistics	
<b>Ambient conditions</b>		
Ambient temperature	-40 ... 70 °C (-40 ... 158 °F) horizontally mounted no SFP installed -40 ... 65 °C (-40 ... 149 °F) horizontally mounted SFP installed	
Storage temperature	-40 ... 85 °C (-40 ... 185 °F)	
Relative humidity	≤ 95 % non-condensing	
Shock resistance	15 g 11 ms	
Vibration resistance	1 g 10 ... 150 Hz	
Pollution degree	max. 2, according to IEC 60664	
Corrosion resistance	acc. to ISA-S71.04-1985, severity level G3	
<b>Mechanical specifications</b>		
Housing material	stainless steel 1.4301 , PC (Polycarbonate)	
Housing width	227 mm	
Housing height	158 mm	
Housing depth	136.5 mm	
Degree of protection	IP20 according to EN 60529	
Mass	3530 g	
Mounting	DIN rail mounting , wall mounting	
<b>Data for application in connection with hazardous areas</b>		
EU-type examination certificate	TÜV 20 ATEX 8571 X	
Marking	Ⓜ II 3 G Ex ic ec nC [ic] IIC T4 Gc Ⓜ II (3) D [Ex ic Dc] IIIC	
<b>Supply</b>		
Maximum safe voltage	$U_m$	60 V
Interface 1	2-WISE power source	
Voltage $U_o$	17.5 V	
Current $I_o$	105 mA	
Interface 2		
Maximum safe voltage $U_m$	60 V	
Interface 3		
Maximum safe voltage $U_m$	60 V	
Directive conformity		
Directive 2014/34/EU	EN 60079-0:2018 , EN 60079-11:2012 , EN 60079-7:2015+A1:2018 , EN 60079-15:2019 , IEC TS 60079-47:2021	
<b>International approvals</b>		
IECEx approval	IECEx TUR 20.0105X	
Approved for	Ex ic ec nC [ic] IIC T4 Gc [Ex ic Dc] IIIC	
<b>Certificates and approvals</b>		
Patents	This product may be covered by the following patent: US 9,762,409	
<b>General information</b>		
Supplementary information	Observe the certificates, declarations of conformity, instruction manuals, and manuals where applicable. For information see <a href="http://www.pepperl-fuchs.com">www.pepperl-fuchs.com</a> .	

Release date: 2023-08-24 Date of issue: 2023-08-24 Filename: 70121859-100005\_eng.pdf

**Assembly**

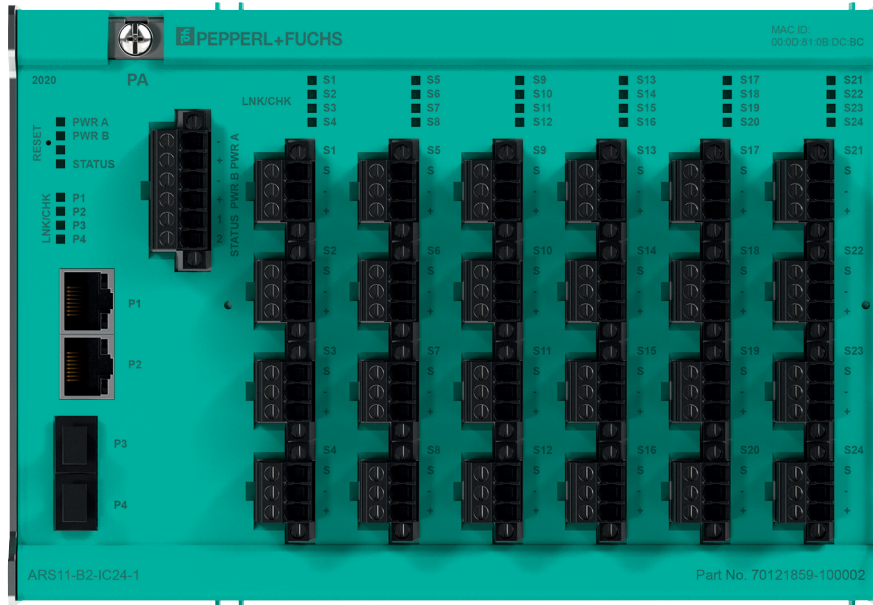

**Mounting**

**Wall Mounting Option**

For wall mounting the APL rail field switch use the accessory ACC-ARS-WM. See manual for details and dimensions.

**Type Code**

ARS1	(1)	B	2	-	IC	(2)	-	(3)
------	-----	---	---	---	----	-----	---	-----

ARS1	Device
ARS1	Ethernet-APL Rail Field Switch

(1)	PROFIBUS PA Proxy
1	With proxy
2	Without proxy

B	Power Supply
B	Separately powered 20 V ... 60 V

2	Uplink Ports
2	2 ports each for RJ45 and SFP slots

IC	Intrinsic Safety at Spurs
IC	Ex ic IIC

(2)	Spur Port Count
08	Spur ports
16	Spur ports
24	Spur ports

(3)	Pluggable Terminal Types
1	Screw terminals
2	Spring terminals

**Accessories**

	<b>ACC-ARS-SW</b>	Separation wall for intrinsically safe port application (packaging unit: 2 pieces)
---	-------------------	--

Release date: 2023-08-24 Date of issue: 2023-08-24 Filename: 70121859-100005\_eng.pdf

Refer to "General Notes Relating to Pepperl+Fuchs Product Information".







Pepperl+Fuchs Group  
www.pepperl-fuchs.com

USA: +1 330 486 0002  
pa-info@us.pepperl-fuchs.com

Germany: +49 621 776 2222  
pa-info@de.pepperl-fuchs.com

Singapore: +65 6779 9091  
pa-info@sg.pepperl-fuchs.com

**Accessories**

	<b>ACC-ARS-WMK</b>	Wall mounting kit consisting of 2 mounting brackets
	<b>ACC-PC-SFP</b>	Protective covers for SFP sockets (packaging unit: 10 pieces)
	<b>ACC-PC-45</b>	Protective covers for RJ45 sockets (packaging unit: 10 pieces)
	<b>SFP-1</b>	SFP transceiver, 2 km, 100BASE-FX, fast Ethernet multimode fiber
	<b>SFP-2</b>	SFP transceiver, 550 m, 1000BASE-SX, Gigabit Ethernet multimode fiber
	<b>DTM FieldConnex</b>	FieldConnex® DTM Collection

Release date: 2023-08-24 Date of issue: 2023-08-24 Filename: 70121859-100005\_eng.pdf

Refer to "General Notes Relating to Pepperl+Fuchs Product Information".

Pepperl+Fuchs Group  
www.pepperl-fuchs.com

USA: +1 330 486 0002  
pa-info@us.pepperl-fuchs.com

Germany: +49 621 776 2222  
pa-info@de.pepperl-fuchs.com

Singapore: +65 6779 9091  
pa-info@sg.pepperl-fuchs.com