

Precision  
Quality  
Innovation

**Starrett®**

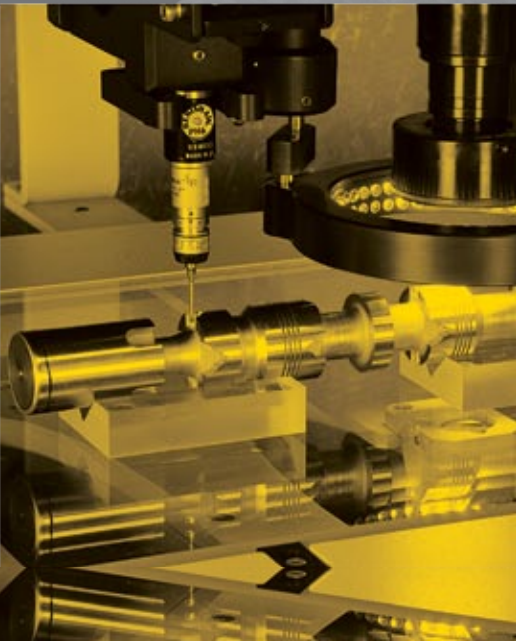

Catalogue 32E

[starrett.co.uk](http://starrett.co.uk)



# Starrett®

After more than 130 years, we remain as dedicated today to the making of great tools for our customers as we were when L.S. Starrett founded the company in 1880. He created a business and a brand that has become synonymous with precision, quality and innovation, backed by unmatched service and support.

We accomplish this by offering application-designed precision tools, saws, and custom solutions that optimise job and process performance. Our confidence hinges on 130 years of experience focusing on your needs and your success. We take great pride in manufacturing long-lasting, easy-to-use tools that provide consistent and reliable performance.

Today, Starrett offers five product categories: Precision Measurement Tools, Metrology Equipment, Granite-based Engineered Solutions, Saw Blades, and Jobsite and Shop Tools.

Whether you need to modify a standard tool, require assistance in selecting the best saw blade for your cutting application or desire a custom solution for your business, we have the breadth of knowledge to assist you.

We are committed to providing you with complete solutions created for your exact needs. Problem solving is part of what we do every day. If the right tool for your application does not exist, contact us – we would appreciate the opportunity to build it.

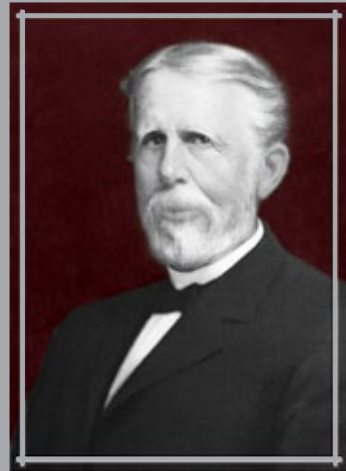

*"I have believed that I could do no greater good than help create a business that would give people employment and a chance to earn an honest living"*  
– L.S. Starrett

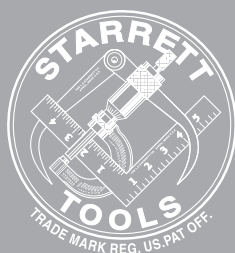







*D.A. Starrett*

President and CEO

Precision, Quality, Innovation

## Table of Contents

	<b>Micrometers . . . . . 1</b>		<b>Surface &amp; Hardness Testers . . . . . 49</b>
	Electronic Outside . . . . . 2		Hardness Testers . . . . . 50
	Mechanical Outside . . . . . 4		Durometer . . . . . 53
	Special Function Outside . . . . . 7		Thickness Tester . . . . . 54
	End Measuring Rods . . . . . 12		Surface Roughness Testers . . . . . 55
	Heads . . . . . 12		
	Depth . . . . . 15		<b>Squares, Precision Rules &amp; Parallels . . . 59</b>
	Inside . . . . . 17		Combination Squares . . . . . 60
	<b>Slide Calipers . . . . . 19</b>		Double Squares . . . . . 64
	Electronic . . . . . 20		Solid Squares . . . . . 65
	Vernier . . . . . 24		Precision Rules . . . . . 66
	Dial . . . . . 24		Parallels . . . . . 68
	<b>Depth &amp; Height Gauges . . . . . 25</b>		<b>Fixed Gauges . . . . . 69</b>
	Electronic Depth Gauges . . . . . 26		
	Electronic Height Gauges . . . . . 27		<b>Precision Shop Tools . . . . . 75</b>
	Dial & Digital Height Gauges . . . . . 32		Precision Levels . . . . . 76
	<b>Hole &amp; Slot Gauges . . . . . 33</b>		Edge Finders . . . . . 78
	Hole Gauges . . . . . 34		Calipers & Dividers . . . . . 79
	Dial Bore Gauges . . . . . 36		Pin Vises . . . . . 80
	<b>Indicators &amp; Gauges . . . . . 37</b>		Scribers . . . . . 81
	Electronic . . . . . 38		Tap Wrenches . . . . . 81
	Dial . . . . . 40		Punches . . . . . 82
	Holdings . . . . . 42		Precision Gauge Blocks . . . . . 86
	Special Function . . . . . 44		Saw Tension Gauge . . . . . 87
			<b>Index . . . . . 90</b>



World Headquarters  
Athol, Massachusetts, USA

## The Standard of Precision Worldwide



Laguna Hills, California, USA



Mount Airy, North Carolina, USA



Cleveland, Ohio, USA



Waite Park, Minnesota, USA



## A Global Manufacturer for Over Half a Century

Starrett's success as a global manufacturer began in the 1950's with the establishment of facilities in Brazil and the United Kingdom. Today, Starrett has nine manufacturing locations worldwide: The U.K., Brazil, China, and five in the United States.

For those who work with their hands to build or manufacture, there is no better way to ensure the accuracy of a critical dimension than to measure it with a Starrett precision tool.

The Starrett name is your assurance of unmatched precision and quality. After more than 130 years, Starrett remains "The World's Greatest Toolmaker" – setting the continuing standard of excellence.



Jedburgh, Scotland



Itu, São Paulo, Brazil



Suzhou, China



## Precision

At Starrett, we understand precision. For generations, the precision that we build into our products has allowed our customers to ensure the quality of their products. Precision is something we take very seriously.

### Primary Standards

To ensure accuracy, manufacturers must enforce strict quality control processes. This starts with applying primary standards for measurement and inspection. This will ultimately lead to consistent, reliable gauging results.

Precision gauge blocks are the primary standards vital to dimensional quality control in the manufacture of interchangeable parts. These blocks are used for calibrating precision measuring tools and for setting numerous comparative type gauges.

However, even gauge blocks are held to their own level of higher standards-- Grand Master Blocks.



## Accuracy

Starrett precision measuring tool accuracies are based on their traceability through our grand master gauge blocks as certified by the National Institute of Standards and Technology (NIST).

Worldwide, no one else has produced the accuracy and stability of Starrett-Webber crobiox® Grand Masters.

They were produced in 1955 out of chromium carbide material to an accuracy within one millionth of an inch (.0000254mm) and have been checked periodically by the National Bureau of Standards and the National Institute of Standards and Technology (NIST). They have remained stable over this period.

### Accurate Reference Surfaces

Every linear measurement depends on an accurate reference surface from which final dimensions are taken.

Precision Granite Surface Plates provide the best reference plane for work inspection and layout prior to machining.

They are also ideal bases for making height measurements and gauging surfaces, parallelism, etc. A high degree of flatness, stability, overall quality and workmanship also make them ideal bases for mounting sophisticated mechanical, electronic and optical gauging systems.



## Quality

Starrett precision measuring products are inspected for accuracy with standards traceable to our grand master gauge blocks.

After a period of use, precision measuring tools require regular preventative maintenance, periodic calibration and, sometimes, repair.

Starrett facilities worldwide offer a variety of repair and calibration services, and have earned appropriate accreditations and certifications as detailed below.

## Calibration & Repair

### Starrett Tools & Gauges – Athol, MA

- Calibration of Starrett Precision Tools
- Accredited by A2LA in accordance with ANSI/NCSL Z540-1 and ISO/IEC 17025



### \*The L. S. Starrett Company, Ltd. – Jedburgh TD8 6LR, Scotland

- ISO 9001 accredited for precision tool, band saw blade, and hole saw manufacturing

### Starrett Indústria e Comércio Ltda. – Itu, S.P., Brazil

- Certified by INMETRO for the calibration of measuring tools and gauge blocks
- Received ISO 9001 accreditation for the manufacture of hand and power hacksaw blades, band saw blades, and hole saws



INMETRO

### \*Starrett Webber Gauge Division – Cleveland, OH

- Accredited calibrations of Linear Gauge Blocks, Webber Height Gauges and Standard Reference Bars, Angle Gauge Blocks, True Squares, Optical Cubes, Optical Polygons and Optical Flats
- Accredited by NVLAP in accordance with ANSI/NCSL Z540-1 and ISO/IEC 17025\*
- Calibrations also performed in accordance with ISO 10012-1 and former MIL-STD-45662A



### \*Starrett Granite Division – Waite Park, MN

- Calibration of granite surface plates, granite parallels, granite straight edges, granite tri-squares, granite angle plates and granite squares
- Surface plate, granite metrology and accessory resurfacing
- Starrett Granite Surface Plates meet or exceed U.S. Federal Specification GGG-P-463c. NIST-traceable calibration certificate provided that is ISO/IEC 17025\* compliant
- ISO 9001:2000 certified and A2LA accredited per the ISO/IEC 17025\* standard



### Starrett Metrology Division – Laguna Hills, CA

- Factory or field Calibration and repairs of Optical Projector and Vision Systems performed by our factory trained experts
- First generation NIST traceable documentation for all calibration artifacts and standards



\* Accreditations are site-specific and tool-specific. The Scope of Accreditation is available upon request to each location.

Specifications and Certifications are subject to change.

## Innovation

### Application-Focused Custom Solutions

When you have a Special Measurement Problem, we will help you find the Solution.

One way Starrett stands out from other precision tool providers is our willingness to work directly with customers to develop custom tools.

Over 50 years, Starrett Special Gauge has developed and built thousands of innovative custom measuring solutions. Customers include the energy, aerospace, automotive, food packaging, high-technology plastics and medical components industries as well as NASA and the military.

Even with our broad catalogue of products, some jobs require a custom solution. After we determine that no "off-the-shelf" product is applicable, our engineers begin a dialogue with the customer to develop a custom tool for the specific task. Through a process of consultation, design, prototype machining and testing, we develop a specification to the full satisfaction of our customer.

Similarly, the Starrett Metrology and Starrett Tru-Stone Granite Technologies Divisions work interactively with customers to create custom solutions utilizing their specific expertise and technologies.

At the conclusion of the process, something that could not be measured is measured, and a difficult problem is transformed into an innovative, often elegant solution.

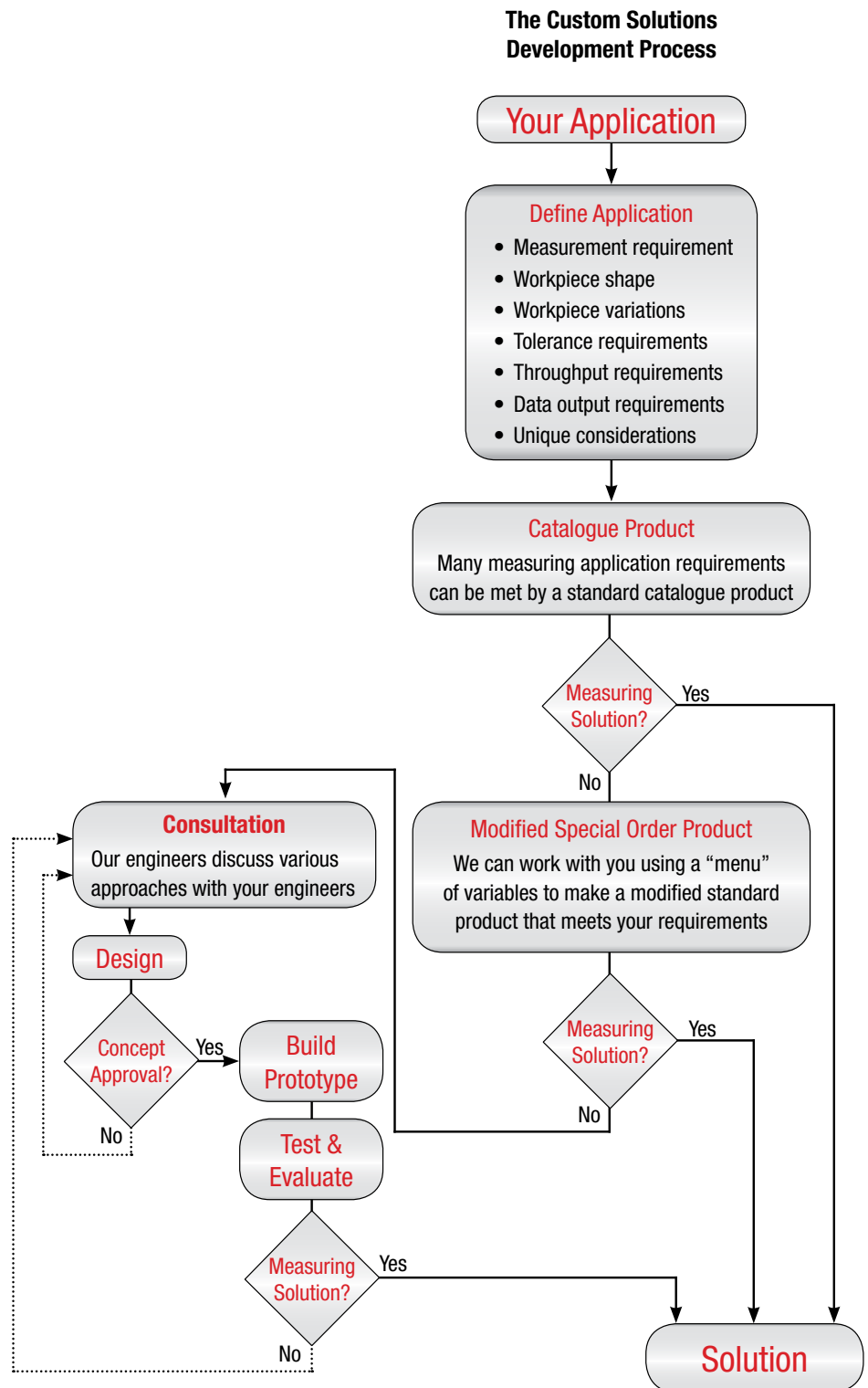



## Tools & Gauges, Engineered Metrology Systems, Granite-based Custom Solutions

### Handheld Tools & Gauges

An interactive process between customer and Starrett engineering personnel created a gauge that measures the diameter of hot steel flat stock while in the heat treatment process. An accurate measurement takes only two seconds of contact, reducing radiant heat transfer and part spoilage.

Its electronic indicator locks the reading in the display for safe reading and is accurate to within  $\pm 0.0762\text{mm}$  ( $\pm .003''$ ).



### Custom Gauge Fixtures

We have worked with many customers to develop a gauge to measure a specific food container, some with lids that must fit precisely – not too tight or loose. These containers are a perfect example of something that defies measurement with a standard tool.

The gauge to the right uses pneumatics to withdraw probes for fast, easy and accurate placement and unloading.

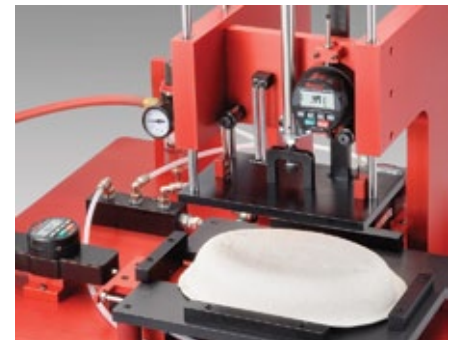

### Engineered Metrology Systems

This application was custom developed with vision and touch probe sensors. As is the case with many recent systems, two or even three sensors are part of the custom solution.

The Starrett Metrology Division works closely with customers to find solutions for complex applications on a regular basis. Their expertise is as important to the solution as the excellence of our system hardware.

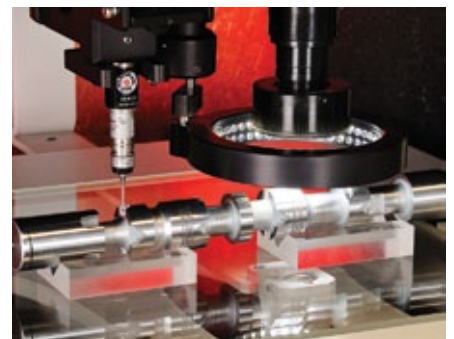

### Granite-based Engineered Solutions

A medical devices manufacturer could not reliably measure a moving tube on a complex 7-axis laser micro machining system because of persistent vibration.

After extensive design consultation with our Starrett Granite Division, the vibration-dampening attributes of granite stabilized beam delivery, allowing measurement of the tubes at a molecular level.

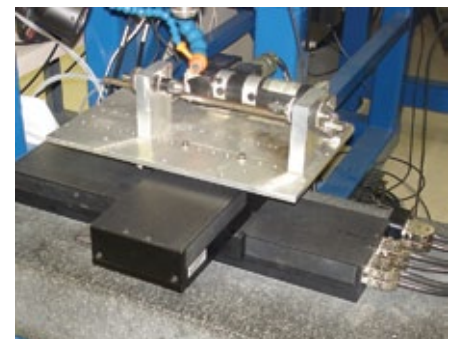



**Items in this catalogue are available from our network of distributors throughout Europe.**



## Micrometers





## 795 & 796 Electronic Micrometers

0-100mm

Starrett 795 and 796 Electronic Micrometers provide an IP67 level of protection against coolant, water, chips, dirt, dust, and other contaminants in hostile shop environments.

The 795 includes an RS232 output port for data transmission. The 796 has all of the features of the 795 except that it does not include output.

These full-featured electronic micrometers are built with customary Starrett quality and workmanship and are now available with measuring capacities to 100mm.

All 795 & 796 Micrometers include a protective case



795MEXFL-100



796MXFL-25

### Features and Specifications

- Large, easy-to-read 7mm, high-contrast LCD digital readout
- IP67 level of protection against coolant, water, dust and dirt
- Starrett no-glare satin chrome finish on thimble and sleeve
- Balanced, tapered frame for comfortable and accurate measuring
- Extremely hard, and stable one piece spindle, the heart of our accuracy and smooth operating one-piece friction thimble
- Two 3-volt batteries included for more than one year of normal usage
- Micro-lapped carbide measuring faces
- Automatic OFF after 20 minutes of nonuse
- Millimetre/inch conversion
- Measurement HOLD button
- Ability to zero tool at any position as well as retain and return to the true zero reading of the micrometer
- Resolution: 0.001mm
- Accuracies:  $\pm 0.002\text{mm}$
- 795 micrometers include RS232 output
- Output data to Starrett SPC Plus hardware and software and to PCs

#### 795 Electronic Micrometers with Output

Range	Friction Thimble, spindle lock, shell & thimble metric grads.	Cat. No.	EDP
0-25mm / 0-1"		795MEXFL-25	69077
25-50mm / 1-2"		795MEXFL-50	69078
50-75mm / 2-3"		795MEXFL-75	69079
75-100mm / 3-4"		795MEXFL-100	69080

#### 796 Electronic Micrometers without output

0-25mm		796MXFL-25	69084
--------	--	------------	-------

#### 795 Electronic Micrometer Accessories

1m Shielded Cable to Starrett 795	PT62680-1*	62021
2m Shielded Cable to Starrett 795	PT62680-2*	62022
3m Shielded Cable to Starrett 795	PT62680-3*	62023
Adaptor from PT62680-1, PT62680-2 and PT62680-3 to PC (RS232)	PT61768*	66454

\* Not Stocked

An IP number is composed of two numbers, the first referring to protection against solid objects and the second against liquids.

First number 6: Totally protected against dust

Second number 7: Protection against submersion in water under standardized conditions of pressure for 30 minutes.



## 3732 & 733 Electronic Micrometers

### 0-600mm

- 733 micrometers include data output port
- Large, high-contrast LCD readout
- Automatic OFF after 30 minutes of nonuse
- 6.35mm spindle diameter
- Smooth friction thimble for uniform pressure
- Micro-lapped carbide measuring faces
- No-glare black wrinkle finish on frame
- No-glare satin chrome finish on thimble and sleeve
- Balanced frame design for comfortable and accurate measuring
- Ring-type knurled lock nut for quick and sure locking
- mm graduations on shell and thimble
- Instant millimetre/inch conversion
- Measurement HOLD button
- Ability to zero tool at any position
- Ability to retain and return to the true zero reading of the micrometer
- PRESET button to install any reading at any position
- Includes one 3-volt battery for over one year of normal usage
- Includes fitted plastic case



3732MEXFL-25



3732MEXFL-100



733MEXFL-25

### 3732 Micrometers without output

Cat. No.	EDP	Range		Resolution		Accuracy	
3732MEXFL-25	12274	0-25mm	0-.984"	0.001mm	0.00005"	± 0.002mm	± 0.0001"
3732MEXFL-50	12275	25-50mm	.984-1.968"			± 0.003mm	
3732MEXFL-75	12276	50-75mm	1.968-2.953"			± 0.004mm	
3732MEXFL-100	12277	75-100mm	2.953-3.937"		0.0001"	± 0.004mm	
3732MEXFL-125	12278	100-125mm	3.937-4.921"			± 0.004mm	
3732MEXFL-150	12279	125-150mm	4.921-5.905"			± 0.004mm	

### 733 Electronic Micrometers with output

733MEXFL-25	65440	0 - 25mm	0-.984"	0.001mm	.00005"	± 0.002mm	± 0.0001"
733MEXFL-50	65441	25 - 50mm	.984-1.968"	0.001mm	.00005"	± 0.003mm	
733MEXFL-75	66079	50 - 75mm	1.968-2.950"			± 0.004mm	
733MEXFL-100	66080	75 - 100mm	2.950-3.930"			± 0.004mm	
733MEXFL-125	66081	100 - 125mm	3.930-4.920"	.0001"	± 0.004mm		
733MEXFL-150	66082	125 - 150mm	4.920-5.900"		± 0.004mm		

### Accessories

Cat. No.	EDP	Description
PT61963*	66636	Computer Interface Cable Complete to PC (RS232C)
PT61768*	66454	Adaptor from PT22938 Cable to PC (RS232C)
PT22938*	64059	Shielded Cable to 761/772 Starrett Modules and PT61768 Adaptor

\* Not Stocked

All except 733MEXFL-25 furnished with standards.

Accuracies above 25mm are as good as setting to a gauge because the mechanical and electronic components are the same on all ranges.



## 436 Outside Micrometers & Sets 0-600mm

- The most popular precision micrometers used by skilled workmen worldwide
- Accurate, rugged, and easy to use
- Anvils sized at 6.35mm diameter

### Readability

- Starrett satin chrome finish – no glare – resists rust
- Advanced sleeve design with staggered lines and distinct figures for precise and easy readability

### Ease-of-Handling

- Ratchet stop
- Carbide measuring faces
- Balanced frame and thimble design ensure easy handling
- Ring-type knurled lock nut for quick and sure locking
- Smooth friction thimble for uniform pressure, the combination ratchet and speeder for uniform pressure and quicker adjustment, or a plain micrometer that depends on your own “feel”
- Gracefully designed tapered frame for use in narrow slots and tight places

### Accuracy and Long-Life

- Rigid steel frame ribbed for extra strength on sizes through 150mm
- Extremely hard and stable one-piece spindle (the heart of our accuracy)
- Micro-lapped measuring faces
- Quick and easy adjustment

### Sets

- Recommended for mechanics, automotive service and machine shops, toolrooms, inspection departments, and wherever gauging involves a wide range of measurements
- Attractive, protective cases keep micrometers and standards together, readily accessible.



436.1MXL-50

436 Outside Micrometers				
Cat. No.	EDP	Range	Graduation	Description
436.2MXRL-25	12755	0-25mm	0.01mm	Ratchet Stop, Lock Nut, Carbide Faces
V436.2MXRL-25	12766		0.001mm	
436.1MXRL-50	68053	25-50mm	0.01mm	
V436.1MXRL-50	68054		0.001mm	
436.1MXRL-75	68056	50-75mm	0.01mm	
V436.1MXRL-75	68057		0.001mm	
436.1MXRL-100	68059	75-100mm	0.01mm	
V436.1MXRL-100	68060		0.001mm	
436.1MXRL-125	68062	100-125mm	0.01mm	
V436.1MXRL-125	68063		0.001mm	
436.1MXRL-150	68065	125-150mm	0.01mm	
V436.1MXRL-150	68066		0.001mm	
436MXRL-175	51706	150-175mm	0.01mm	
436MXRL-200	51734	175-200mm		
436MXRL-225	51762	200-225mm		
436MXRL-250	51790	225-250mm		
436MXRL-275	51818	250-275mm		
436MXRL-300	51846	275-300mm		
Outside Micrometer Sets				
S436MEXRLZ	52014	0-300mm	0.01mm	Set Includes: 25, 50, 75, 100, 125, 150, 175, 200, 225, 250, 275 & 300mm Micrometers, with Eleven Standards, in Case
S436.2MCXRLZ	12776	0-150mm	0.01mm	Set Includes: 25, 50, 75, 100, 125 & 150mm Micrometers, with Five Standards, in Case

25-150mm models sent in fitted plastic case.  
175-300mm models sent without case, packed one each to a box.



444MXRL150

## 444 Outside Micrometers with Insulated Frames

0-150mm

- Micrometer with a thermal insulator cover mounted on the frame to avoid measuring errors
- Rigid one piece frame of drop forged steel
- Extremely hard and stable one piece spindle
- Micro lapped carbide measuring faces



## 3206 Outside Micrometer Stand

- This stand converts outside micrometers to a sturdy bench gauge for batch inspection of small parts
- Useful as a handy bench vise or assembly fixture
- Gripping surfaces are two replaceable nylon pads
- Ball joint construction allows head to be positioned as much as 30° off perpendicular in any direction
- Positive lock on the base
- Base dimension is 162mm long x 89mm wide x 19mm thick
- Tilting head clamping capability is 19mm thick x 25mm throat depth
- Accommodates all Starrett 13mm and 25mm outside micrometers, 2 and 2A outside micrometers and 210, 220, 483, 485, 569 special purpose outside micrometers

444 Micrometers (0-150mm Range)			
Cat. No.	EDP	Range	Graduation
444MXRL-25	11980	0-25mm	0.01mm
444MXRL-50	11981	25-50mm	0.01mm
444MXRL-75	11982	50-75mm	0.01mm
444MXRL-100	11983	75-100mm	0.01mm
444MXRL-125	11984	100-125mm	0.01mm
444MXRL-150	11985	125-150mm	0.01mm

3206 Outside Micrometer Stand		
Cat. No.	EDP	Description
3206	68917	Outside Micrometer Stand



## 224 Interchangeable Anvil Micrometers 0-600mm

Unusual flexibility, plus a wide range of measurement makes the Starrett 224 satin-chrome micrometers very popular in machine or automotive repair shops and for all applications requiring a versatile micrometer.

Each micrometer is equipped with a series of easily interchangeable anvils, thus providing the full range in steps of 25mm with a single micrometer. Suitable wrenches are furnished to make necessary adjustments.

These larger sizes have 7.6mm anvil and spindle diameters for ease of use on larger work.

### Readability features

- Starrett satin chrome finish – no glare – resists rust
- Advanced sleeve design with staggered lines and distinct figures for precise and easy readability
- Large thimble diameter with distinct figures

### Ease-of-Handling Features

- Balanced frame and thimble design ensure easy handling and better readability
- Ring-type knurled lock nut for quick and sure locking
- Combination ratchet and speeder for uniform pressure and quicker adjustment

### Accuracy and Long-Life Features

- Rigid and stable special cast iron frame with appropriate perforations for lightness and ribbed for strength and stability
- Extremely hard and stable one-piece spindle (the heart of our accuracy)
- Interchangeable anvils
- Micro-lapped measuring faces
- Quick and easy sleeve adjustment



224MAARLZ in Case



224MAARLZ pictured without case

224 Interchangeable Anvil Micrometers				
Range	Graduation	With Ratchet Stop, Lock Nut, In Case		234 Standards Furnished
		Cat. No.	EDP	
0-100mm	0.01mm	224MAARLZ	50771	25, 50, 75mm
50-150mm		224MARLZ	50773	50, 75, 100, 125mm
150-300mm		224MGRLZ	50777	150, 175, 200, 225, 250, 275mm
300-400mm		224MDRLZ	50781	300, 325, 350, 375mm
400-500mm		224MERLZ	50783	400, 425, 450, 475mm
500-600mm		224MJRLZ	50785	500, 525, 550, 575mm





## 256 Disc-Type Micrometers with rotating or non-rotating spindles

### 0-75mm

These tools are used to measure the thickness of work sections such as ribs, lands, fins, cutting edges on form tools, and chordal thickness of gear teeth. Because of their large anvil and spindle faces, the 25mm size is also useful for measuring the thickness of sheet materials like paper, cardboard, rubber, and plastics.

#### Readability Features

- Starrett satin chrome finish – no glare – resists rust
- Advanced sleeve design with staggered lines and distinct figures for precise and easy readability
- Quick-reading figures

#### Ease-of-Handling Features

- Balanced frame and thimble design ensure easy handling and better readability
- Ring-type knurled lock nut for quick and sure locking
- Combination ratchet and speeder for uniform pressure and quicker adjustment on all sizes
- Gracefully designed tapered frame for use in narrow slots and tight places
- Anvil and spindle discs are 12.7mm diameter tapering to 0.4mm edge thickness making it possible to enter narrow grooves and recesses
- Available in 25mm size with rotating or non-rotating spindle

#### Accuracy and Long-Life Features

- Rigid one-piece frame of drop forged steel
- Extremely hard and stable one-piece spindle (the heart of our accuracy)
- Micro-lapped measuring faces
- Quick and easy adjustment
- Starrett workmanship
- This tool is accurate to  $\pm 0.003\text{mm}$  measuring over the whole surface and  $\pm 0.004\text{mm}$  measuring on the edges



256MPN-25



256MRL-50

#### 256M Disc-Type Micrometers (0.01mm Graduation)

Range	Description	Cat. No.	EDP
0-25mm	Ratchet Stop, Lock Nut	256MRL-25	51238
0-25mm	With Non-Rotating Spindle	256MPN-25	56470
25-50mm	Ratchet Stop, Lock Nut	256MRL-50	55942
50-75mm	Ratchet Stop, Lock Nut	256MRL-75	55943



483MXRL-25



486MP-25

## 483 V-Anvil Micrometers

2-25mm

Used to check out-of-roundness from centreless grinding or other machining operations. Also used for measuring odd fluted taps, milling cutters, and reamers.

### Readability Features

- Direct measuring of three and five-fluted tools
- Starrett satin chrome finish – no glare – resists rust
- Advanced sleeve design for precise and easy readability
- Quick-reading figures

### Ease-of-Handling Features

- Balanced frame and thimble design ensure easy handling and readability
- Ring-type knurled lock nut for quick and sure locking
- Combination ratchet and speeder for uniform pressure and quick adjustment

### Accuracy and Long-Life Features

- Rigid one-piece frame of drop forged steel
- Extremely hard and stable one-piece spindle (the heart of our accuracy)
- Micro-lapped measuring faces
- Carbide facing on spindle and anvils for extra long wear
- Quick and easy adjustment

## 486 Blade Type Micrometers with non-rotating spindle

0-150mm

Here is another special function Starrett micrometer. It is designed for fast and accurate measurements of circular form tools, diameter and depth of narrow grooves, slots, keyways, recesses, and depths between lands and fins.

### Readability Features

- Starrett satin chrome finish – no glare – resists rust
- Advanced sleeve design with staggered lines and distinct figures for precise and easy readability

### Ease-of-Handling Features

- Balanced frame and thimble design ensure easy handling and better readability
- Speeder for quicker adjustment on all sizes
- Non-rotating spindle prevents blade from turning in narrow slots or rolling off shoulder
- The blades are 0.8mm thick
- Blades will measure to 8mm depths

### Accuracy and Long-Life Features

- Rigid steel frame ribbed for extra strength on sizes through 150mm
- Extremely hard and stable one-piece spindle (the heart of our accuracy)
- Quick and easy adjustment

#### 483 V-Anvil Micrometers

Cat. No.	EDP	Range	Graduation	No. of Flutes It Will Measure	Description
483MXRL-25	56046	2-25mm	0.01mm	3	Ratchet Stop, Lock Nut, Tapered Spindle

#### 486 Blade Type Micrometers (0-100mm Range)

Cat. No.	EDP	Range	Graduation	Description
486MP-25	64257	0-25mm	0.01mm	With Speeder
486MP-50	64258	25-50mm		
486MP-75	64259	50-75mm		
486MP-100	64260	75-100mm		



## 576 & 577 Micrometers with rounded anvils

0-13mm & 0-25mm

These micrometers are all extremely useful for measuring the wall thickness of parts such as solid and split bearings, tubing, sleeves, collars, rings, various cylinders, and also measuring from the inside of a hole to an edge. Both have a rounded anvil which contacts the inside curved surface and a flat spindle for contacting the outside of the work, thus producing single point contact. This permits accurate gauging of curved surface thickness in hundredths of a millimetre.

### Capacity:

- The 576 can access holes as small as 8mm and measure up to 13mm
- The 577 can access holes as small as 9.5mm and measure up to 25mm

### Readability Features

- Starrett satin chrome finish – no glare – resists rust
- Advanced sleeve design with staggered lines and distinct figures for precise and easy readability

### Ease-of-Handling Features

- Balanced frame and thimble design ensure easy handling and readability
- Gracefully designed tapered frame for narrow slots and tight places

### Accuracy and Long-Life Features

- Rigid steel frames
- Extremely hard and stable one-piece spindle (the heart of our accuracy)
- Micro-lapped measuring face
- Quick and easy adjustment

## 207 & 208 Stainless Steel Can Seam Micrometers

Starrett Can Seam Micrometers are made of stainless steel and designed to measure the thickness and depth of can seams.

The 207 micrometer is used to measure the seam at outside bottom edge of dome on top of aerosol cans. The 208 micrometer is used to measure thickness of seam at top and bottom of flat-topped cans. 208D is used to measure thickness and depth of all standard can seams.

### Readability Features

- Satin finish stainless steel – no glare – rust and stain resistant
- Advanced sleeve design with staggered lines and distinct figures for precise and easy readability
- Quick-reading figures

### Ease-of-Handling Features

- The 207 has a snub nose which permits measuring aerosol type cans

### Accuracy and Long-Life Features

- Extremely hard and stable one-piece spindle (the heart of our accuracy)
- Quick and easy adjustment

#### 576 & 577 Micrometers (0-25mm Range)

Cat. No.	EDP	Range	Graduation	Description
576MXR	66442	0-13mm	0.01mm	Ratchet Stop, Full Finish Tapered Frame, Carbide Faced Spindle
577MXP	66444	0-25mm		Full Finish Tapered Frame, Carbide Faces

#### 207 & 208 Stainless Steel Can Seam Micrometers (0-9.5mm Range)

Cat. No.	EDP	Graduation	Description
207MZ	64337	0.01mm	Snub Nose for Aerosol Cans
208MZ	64338		Without Depth Gauge
208MDZ	63191		With Depth Gauge (5mm Range)



## 220 Mul-T-Anvil Micrometer

0-50mm

This tool was a new development in micrometer design and patent is held by Starrett. This micrometer will handle a wide variety of measurements impossible to obtain with regular micrometers, such as measuring the wall thickness of tubing, cylindrical walls from a hole or slot to an edge, many hard-to-reach locations, and the thickness of screw heads, shoulder lengths, etc.

A most interesting feature of this tool is that additional anvils of various shapes can be made up, and many of these anvils do not have to be hardened for that “special job”.

This micrometer is furnished with 0.01mm graduations for easier and more accurate readings. The Starrett Company, with our years of experience, recommends this because the anvils on this type of tool are not backed up by a frame as in a regular micrometer and could bend slightly.

### Ease-of-Handling Features

- Balanced frame and thimble design ensure easy handling, better readability
- Ring-type knurled lock nut for quick and sure locking
- A choice of smooth friction thimble for uniform pressure or the combination ratchet and speeder for uniform pressure and quicker adjustment
- Interchangeable anvils are rigidly held in the vise type frame and quickly interchanged by a single lock screw adjustment
- Two hardened anvils furnished – round anvil approximately 3mm diameter and flat anvil approximately 3mm and 1.5mm thick
- “V” Anvil for measuring thickness of screw heads and shoulder lengths available separately
- Accommodates special anvils up to 8mm thick
- Can be used as a height gauge by removing the vise jaw

### Readability Features

- Starrett satin chrome finish – no glare – resists rust
- Advanced sleeve design with staggered lines and distinct figures for precise and easy readability
- Quick-reading figures

### Accuracy and Long-Life Features

- Rigid one-piece frame of drop forged steel
- Extremely hard and stable one-piece spindle (the heart of our accuracy)
- Micro-lapped measuring faces
- Quick and easy adjustment
- Tool is accurate to  $\pm 0.004\text{mm}$

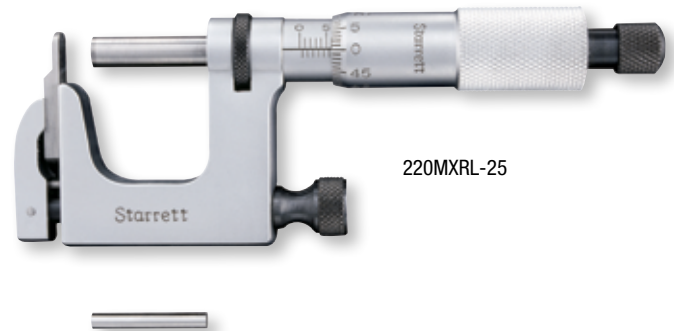

220MXRL-25

### 220 Mul-T-Anvil Micrometers With Round and Flat Anvils and Carbide Faced Spindle

Range	Graduation	Ratchet Stop, Lock Nut	
		Cat. No.	EDP
0-25mm	0.01mm	220MXRL-25	65050

V-Anvil only: Order PT13017, EDP 71399  
Furnished in fitted case.



## 222 Sheet Metal Micrometer

0-25mm

These micrometers reach over the edge of sheet metal and take measurements away from the edge toward the centre. Also for other gauging jobs where a deep throat micrometer is needed. Rounded anvil on 25mm size gives a point contact for more accurate gauging; flat anvil is also available. The 25mm micrometer frames have black wrinkle finish.

### Readability Features

- Starrett satin chrome finish – no glare – resists rust
- Advanced sleeve design with staggered lines and distinct figures for precise and easy readability

### Ease-of-Handling Features

- Balanced frame and thimble design ensure easy handling and better readability
- Combination ratchet and speeder for uniform pressure and quicker adjustment

### Accuracy and Long-Life Features

- Rigid one-piece frame of drop forged steel, ribbed for strength and stability
- Extremely hard and stable one-piece spindle (the heart of our accuracy)
- Micro-lapped measuring face
- Quick and easy adjustment



222MBXR-25

### 222 Sheet Metal Micrometer, 150mm Throat Depth (0-25mm Range)

Cat. No.	EDP	Anvil	Graduation	Description
222MAXR-25	66435	Rounded	0.01mm	Ratchet Stop, Carbide Faces

Sent with rounded anvil unless otherwise ordered.  
Packed one in a box without case.



234MA-100 & 234MA-300



263MRL

## 234 End Measuring Rods with spherical ends

### 25-600mm

These rods or “standards” are for checking and setting micrometers of 50mm capacity and larger, and are also used on machine tools for comparing gauges, checking precision measuring tools, for measuring parallel surfaces, and many other types of work.

They are made of special tool steel in rod form with ends hardened and accurately lapped to a spherical radius.

Supplied with insulated handles to minimize expansion by heat when held in the hand. 25-150mm sizes are 6.3mm diameter; 175-275mm sizes, 9.5mm diameter; 300mm size is 11mm diameter.

NOTE: These standards are used for all micrometers furnished with standards. Larger sizes available on special order.

## 263 Micrometer Heads

### 0-25mm

- Reading surfaces satin-finished for easy readability
- No-glare, satin chrome finish
- Available with reverse reading, if needed
- Ring-type knurled lock nut for quick and sure locking
- Choice of smooth friction thimble for uniform pressure, combination ratchet and speeder for uniform pressure and quicker adjustment, or a plain micrometer head that depends on your own “feel”
- Spindle face available plain or with carbide
- Furnished with 12.7mm diameter clamping surface, but also available with 9.5mm clamping diameter on special order

#### 234 End Measuring Rods

	Cat. No.	EDP
25mm	234MA-25	50970
50mm	234MA-50	50972
75mm	234MA-75	50974
100mm	234MA-100	50976
125mm	234MA-125	50978
150mm	234MA-150	50980
175mm	234MA-175	50982
200mm	234MA-200	50984
225mm	234MA-225	50986
250mm	234MA-250	50988
275mm	234MA-275	50990
300mm	234MA-300	50992

#### 263 Micrometer Heads

Range	Graduation	Cat. No.	EDP	Description
0-25mm	0.01mm	263MP*	51275	Plain
		263ML*	51276	Lock Nut
		263MRL*	51257	Ratchet Stop, Lock Nut
	0.001mm	V263MRL*	55962	Ratchet Stop, Lock Nut

\* Specify clamping diameter 12 or 12.7mm. 12.7mm sent unless otherwise ordered.



460MB



463MRL

## 460 Micrometer Heads 0-13mm

Plain micrometer heads with no lock nut or ratchet.

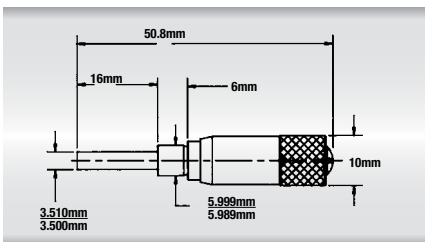

460MB (0-13mm) dimensions

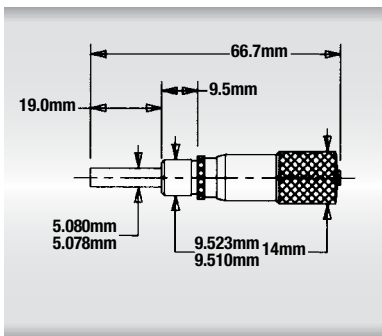

463MP (0-13mm) dimensions

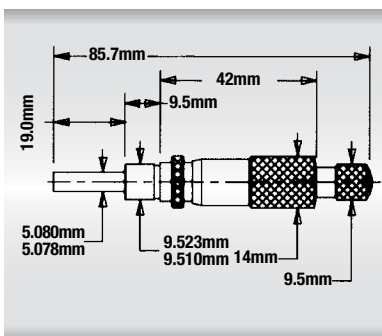

463MRL (0-13mm) dimensions

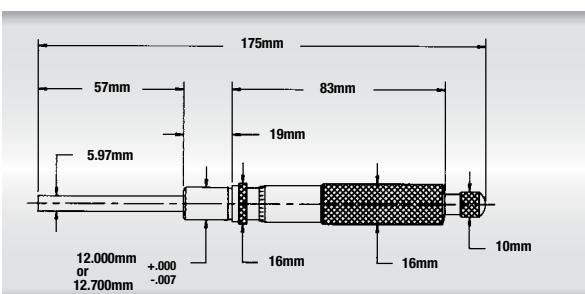

63MRL (0-50mm) dimensions

## 463 Micrometer Heads 0-13mm

The 463 is made from rust-resistant stainless steel. The reading surfaces are satin finished stainless steel for easy readability. Heads are available with the features below:

- Either combination ratchet and speeder for uniform pressure and quicker adjustment, or plain micrometer heads that depend on your own feel
- Ring-type lock nut for quick and sure locking at any setting
- Reverse reading, if needed
- Plain or carbide spindle faces



63MRL

## 63 Long Range Micrometer Heads

0-50mm

When long spindle travel is required, the 63 micrometer heads provide a range that will handle most applications, such as in electronic equipment, machine tools, special gauges, tooling, etc.

460 Micrometer Heads				
Range	Graduation	Cat. No.	EDP	Description
0-13mm	0.01mm	460MB	64447	Plain
463 Micrometer Heads				
0-13mm	0.01mm	463MP	52444	Plain
		463MRL	52452	Ratchet Stop, Lock Nut
63 Micrometer Heads				
0-50mm	0.01mm	63MRL*	55939	Ratchet Stop, Lock Nut

\* Specify clamping diameter 12mm or 12.7mm. 12.7mm sent unless otherwise ordered.



762MEXFL-50

## 762 Electronic Micrometer Heads with rotating or non-rotating spindles (with output)

0-50mm / 0-2"

### Readability Features

- Large digital readout is easy to read, reducing errors
- Attractive black wrinkle finish on frame
- Starrett no-glare satin chrome finish on thimble and sleeve

### Ease-of-Handling Features

- Ring-type knurled lock nut
- Smooth friction thimble for uniform pressure on regular heads and combination ratchet and speeder on non-rotating heads

### Accuracy and Long-Life Features

- Extremely hard and stable one-piece spindle (the heart of our accuracy)
- Micro-lapped carbide face
- One 3-volt battery furnished for over a year of normal usage
- Auto OFF after 30 minutes of non use

### Full-Function Action Features

- Millimetre/Inch conversion
- Turn on in millimetre mode after battery installation
- Measurement HOLD button
- Ability to zero tool at any position
- Ability to retain and return to the true zero reading of the micrometer
- PRESET button to install any reading at any position
- RS232 data output port

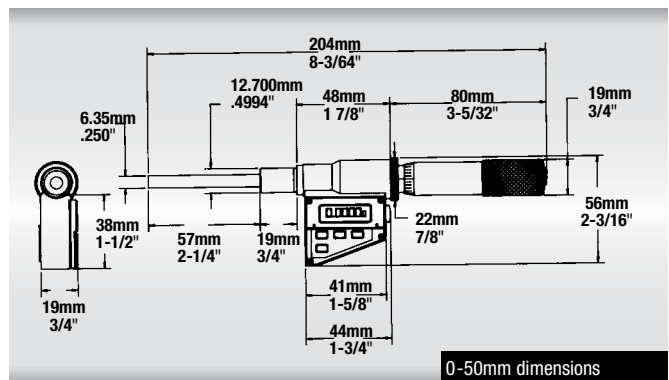
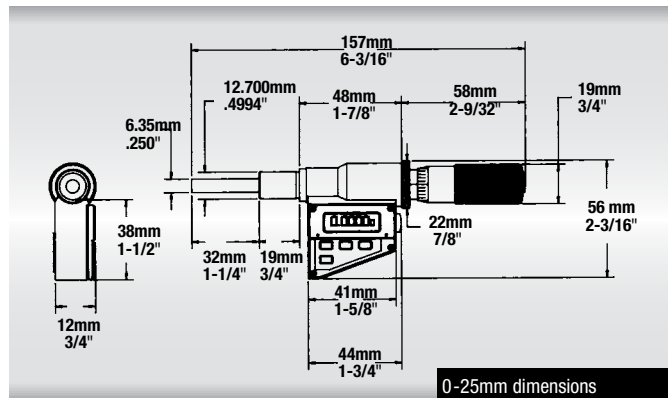

#### 762 Micrometer Specifications

	Millimetre	Inch
<b>Resolution</b>	0.001mm	.00005"
<b>Accuracy</b>	±0.003mm per 25mm	±.0001" per Inch

#### 762 Electronic Micrometer Heads with Standard Millimetre Graduations on Shell and Thimble

Range	Description**	Cat. No.	EDP
0-25mm/0-1"	Friction Thimble, Lock Nut and	762MEXFL-25	66077
0-50mm/0-2"	Carbide Face	762MEXFL-50	66137

#### Cable Information for 762M Electronic Micrometer Heads

Computer Interface Cable Complete to PC (RS232C)	PT61963*	66636
Adaptor from PT22938 Cable to PC (RS232C)	PT61768*	66454
Shielded Cable to 761/772 Starrett Modules and PT61768 Adaptor	PT22938*	64059

\* Not Stocked

\*\* 12.7mm clamping diameter sent unless otherwise specified.





## 440 & 445 Depth Micrometers

### 0-225mm

- Measure depths of holes, slots, shoulders and projections to 0.01mm
- 440 gauges furnished with a 63.5mm base and 3.2mm diameter measuring rods
- 445 gauges furnished with choices of 75mm, 100mm, and 150mm bases and have 4mm diameter measuring rods
- Combination ratchet and speeder for uniform pressure and quicker adjustment
- Ring-type lock nut for quick and sure locking
- With ratchet stop and lock nut in case

## 449 Micrometer Depth Gauges with non-rotating blades

### 0-150mm

By holding the base in one hand, the 1.2mm thick x 3.2mm wide blade can be turned with the fingers and positioned at any angle relative to the base. In operation, blade does not turn, but moves perpendicularly only, permitting depth measurement of narrow shoulders without the blade rolling off. This is also ideal for slots and recesses as narrow as 1.2mm. Furnished with a 63mm or 100mm base.

Also available with 3 rods for measuring 0-75mm, or 6 rods for measuring 0-150mm in 0.01mm increments.

This tool comes with the combination ratchet and speeder for uniform pressure and quicker adjustment.



### 440 & 445 Depth Micrometers (0.01mm Graduation)

Range	Base	Rods	Rod Dia.	Cat. No.	EDP
0-75mm	63.5mm	3	3.2mm	440MZ-75RL	52116
0-150mm		6		440MZ-150RL	52120
0-225mm		9		440MZ-225RL	52124
0-75mm	100mm	3	4mm	445MBZ-75RL	52221
0-150mm		6		445MBZ-150RL	52225
0-225mm		9		445MBZ-225RL	52229

### 449 Micrometer Depth Gauges (0.01mm Graduation)

Range	Base	Rods	Rod Dia.	Cat. No.	EDP
0-75mm	63.5mm	3	1.2 x	449MAZ-75R	56636
0-150mm	63.5mm	6		449MAZ-150R	56637
0-75mm	100mm	3	3.2mm	449MBZ-75R	56638
0-150mm	100mm	6		449MBZ-150R	56639





## 749 Electronic Micrometer Depth Gauge (with output)

0-150mm

The Starrett 749 electronic depth micrometer has a wide range for measuring the depth of most holes, slots, shoulders and projections.

### Readability Features

- Large high-contrast LCD digital readout
- Resolution: 0.001mm
- Millimetre graduations standard
- No-glare black wrinkle finish frame
- No-glare satin chrome finish on thimble and sleeve

### Ease-of-Handling Features

- Ring-type knurled lock nut
- Combination ratchet and speeder

### Accuracy and Long-Life Features

- Ground and lapped one-piece spindle
- Base length 100mm; rod diameter 4mm
- One 3-volt battery capable of over one year's normal usage
- Automatic OFF after 30 minutes of nonuse
- Full-Function Action Features
- Instant millimetre/inch conversion
- Turns on in millimetre mode after battery installation
- Measurement HOLD button
- Ability to zero at any position and retain and return to true zero reading
- PRESET button to install any reading at any position
- Ability to install minimum and maximum limits
- RS232 data output port



749MEBZ-150



### 749 Electronic Micrometer Depth Gauges, Standard Millimetre Graduations on Shell and Thimble

Cat. No.	EDP	Description
749MEBZ-150	66124	0-150mm Range, with Case

### Cable Information for 749 Electronic Micrometer Depth Gauges

Part No.	EDP	Description
PT61963*	66636	Computer Interface Cable Complete to PC (RS232C)
PT61768*	66454	Adaptor from PT22938 Cable to PC (RS232C)
PT22938*	64059	Shielded Cable to 761/772 Starrett Modules and PT61768 Adaptor

\* Not Stocked



124MAZ

## 124 Solid-Rod Inside Micrometer Sets

### 50-800mm

These are the most popular inside micrometers because of their lightness, ease of use, and range. They are very useful for measuring inside diameters of cylinders and rings, measuring parallel surfaces, etc.

The desired range is obtained by assembling rods and spacing collars to the micrometer head. Measuring rods are provided with a shoulder that is set accurately in the micrometer head and locked in position. When assembling rods to the A and B heads, the reading line on the micrometer head should be lined up with the marking on each rod (except 50-75mm rods).

Rod diameters are approximately 6mm on the A and B sizes, and approximately 8.5mm on the C size. Each rod has individual length adjustment for the anvil by means of the supplied special wrenches.

- Measuring rods are solid and assembled on one side of the micrometer head
- Insulated rods marked with length
- Hardened and ground anvils on rods, adjustable for length. Head anvil is hardened and ground
- A convenient handle (length 165mm) is available to provide reach for use in deep holes. Handle screws into the micrometer head in place of the dummy screw, which is opposite a rod lock screw



#### 124 Solid-Rod Inside Micrometer Sets (0.01mm Graduation)

Range	Screw Movement	Measuring Rods	Spacing Collars	With Case Cat. No.	EDP
50-200mm	13mm	6	One 12mm	124MAZ	56141
50-300mm	13mm	10	One 12mm	124MBZ	56142
200-800mm	25mm	4	One 25mm Two 50mm	124MCZ	56143



823MAZ 40-200mm set with tool, rods, handle and wrenches



823M Tubular Inside Micrometer Head



823MEZ 100-1000mm set with tool, rods, handle and wrenches



## 823 Tubular Inside Micrometer Sets

### 40-1000mm

The Starrett 823 micrometers are highly useful tools for internal linear measurements such as measuring cylinders, rings, setting calipers, comparing gauges and measuring parallel surfaces.

The extension rods are made of steel tubing, light in weight, yet extremely rigid. Rods are approximately 9.5mm diameter to meet the requirements of mechanics who prefer this larger diameter. By removing the hardened and ground anvil ends (end caps) of the micrometer head, the rods may be attached to either or both ends of the micrometer as preferred. Each rod may be individually adjusted for wear by the hardened and ground anvil at the end.

- Tubular measuring rods are lightweight, yet extremely rigid. Rods are insulated, with the exception of 13mm and 25mm sizes
- Each rod is marked with length
- Hardened and ground anvils on rods are adjustable for length
- Head anvil is hardened and ground
- Interchangeable anvils on both 13mm and 25mm heads
- Lock nut furnished on 25mm heads
- 140mm long, convenient handle furnished on A, B, F micrometers may be clamped where it will provide correct balance and reach

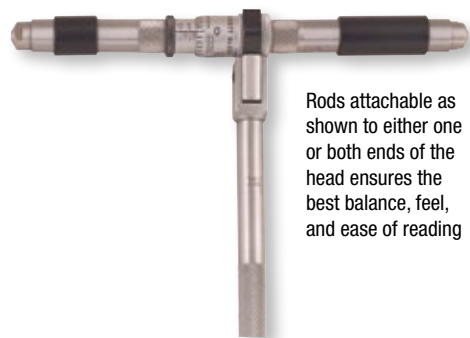

Rods attachable as shown to either one or both ends of the head ensures the best balance, feel, and ease of reading

#### 823 Tubular Inside Micrometer Sets (0.01mm Graduation)

Range	Movement of Screw	Description	Cat. No.	EDP
40-200mm	13mm	With 6 Rods and Handle	823MAZ	53051
40-300mm		With 8 Rods and Handle	823MBZ	53053
100-1000mm	25mm	With 10 Rods	823MEZ	53057

Each set furnished in attractive, protective case with assembly instructions for various measurements.

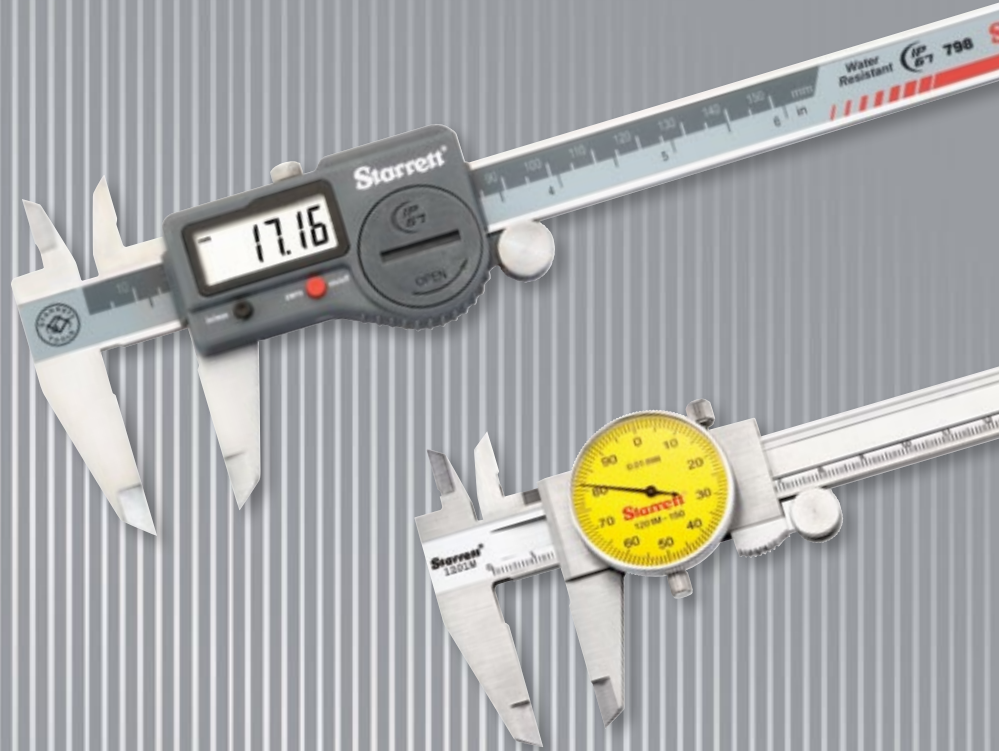

## Slide Calipers





## 798 Electronic Calipers

### 0-300mm

- Large, easy to read LCD, 7.874mm/.310" character height
- IP67\* protection
- Induction type linear encoder system
- 798B Calipers include electronic data output - Patented non-contact RS-232
- Heavy-duty bar and slide, 3.5mm thick
- Hardened stainless steel measuring surfaces for long life
- Fine adjustment
- Slide lock
- Linear accuracy meets DIN862
- 0.010mm/.0005" resolution
- CR2032 3V battery (> 1 year battery life under normal use)
- mm/Inch conversion
- Zero at any position
- Automatic shutoff of the display after 30 minutes of non-use
- Reactivation of display with movement of slide with no loss of position

According to IEC60529, IP67 stands for:



- The first number "6" identifies protection against ingress of dust
- The second number "7" identifies protection against submersion in water under standardised conditions of pressure for 30 minutes.



**Approximate Jaw Depths for 798 Electronic Calipers**

	150mm	200mm	300mm
<b>Outside</b>	38mm	47.6mm	63.5mm
<b>Inside</b>	16mm	19mm	19mm

### 798 Electronic Calipers

Range	Description	Cat. No.	EDP
150mm	Caliper with Output in Fitted Plastic Case	798B-6/150	12521
	Caliper without Output in Fitted Plastic Case	798A-6/150	20798
200mm	Caliper with Output in Fitted Plastic Case	798B-8/200	12523
	Caliper without Output in Fitted Plastic Case	798A-8/200	20799
300mm	Caliper with Output in Fitted Plastic Case	798B-12/300	12525
	Caliper without Output in Fitted Plastic Case	798A-12/300	20800

### Accessories, Cables and Case Information for 798 Electronic Calipers

Description	Cat. No.	EDP
Centre Distance Attachment	PT26151*	64440
Depth Attachment	PT22431*	64640
Non-contact Computer Interface Cable to PC (USB) with Driver CD	PT63329*	12732
Replacement Non-contact Computer Interface Cable to PC (USB)	PT63329-1*	12733

\* Not Stocked

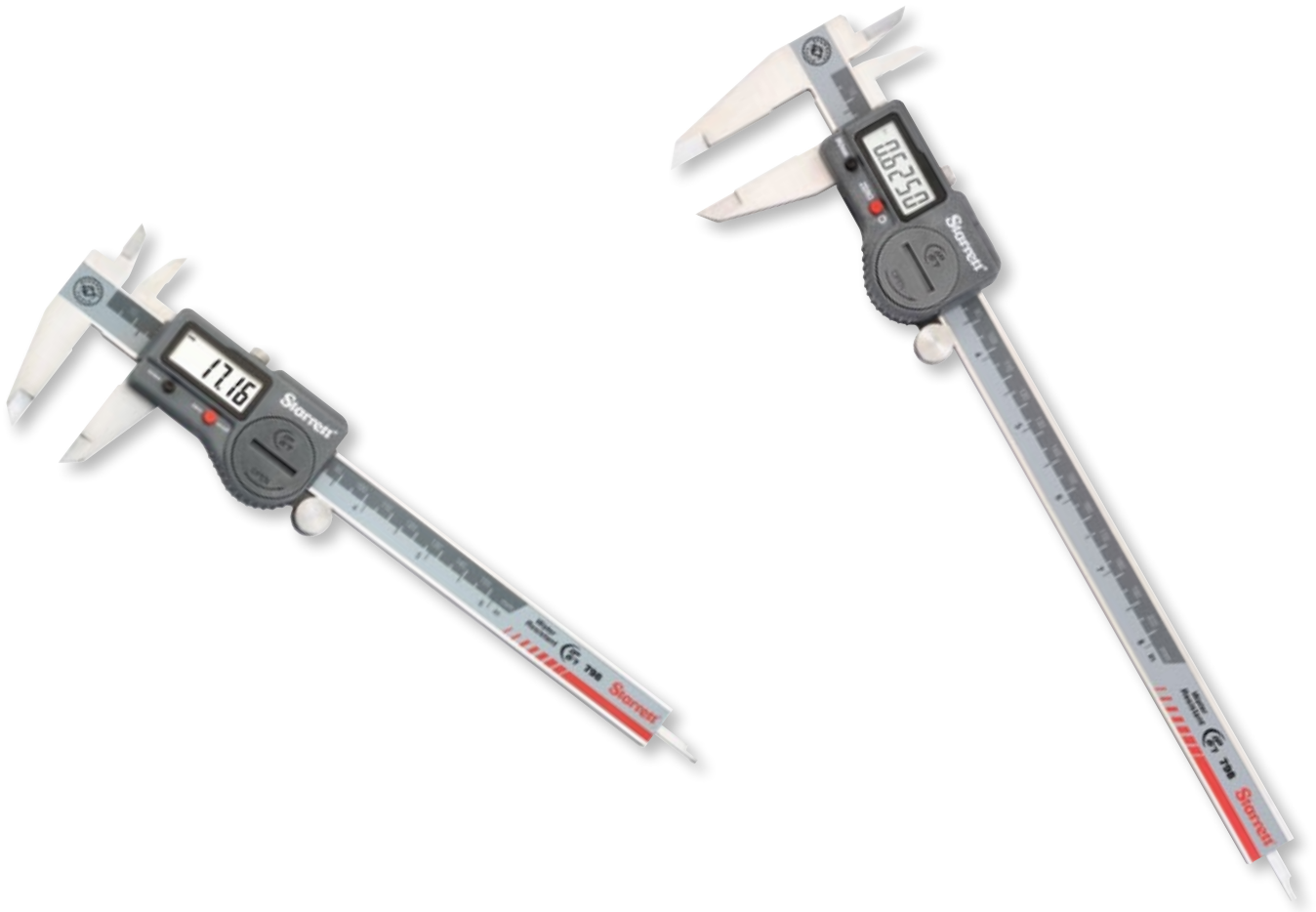



## 799 Electronic Calipers

0-1000mm / 0-40"

Starrett's 799 Electronic Calipers are light, comfortable, easy-to-use, and constructed with features that have made Starrett slide calipers the machinist's first choice for many years.

The 799 offers a slim, streamlined profile, a large, clear, easy-to-read LCD display, long battery life, and function buttons for zero and mm/inch.

799 calipers are available in 150, 200, and 300mm sizes and the newly available extended range 600mm and 1000mm. All sizes furnished in a fitted, protective case.

### Features (all sizes)

- Lightweight, ergonomic design
- Millimetre/inch conversion reads 0.01mm or .0005"
- Easy access to the single, long-life battery
- Last measuring position retained when shut off
- Hardened stainless steel body for long life
- Fine adjustment thumb wheel
- Lock screw to hold the slide in position
- Resolution is 0.01mm / .0005"
- Zero at any position

### 150, 200 & 300mm Calipers Only

- Large easy-to-read LCD, 8mm/.32" high characters
- Automatic shut-off after 5 minutes of nonuse
- Linear accuracy meets DIN862
- Integrated depth rod

### 600 & 1000mm Calipers

- Preset and hold feature
- Minimum and maximum limits set
- I.D. jaw dimension is 20.32mm/0.800"
- LCD characters are 12.7mm/.50" high
- Auto shut-off after 30 minutes of non-use



799AZ-24/600

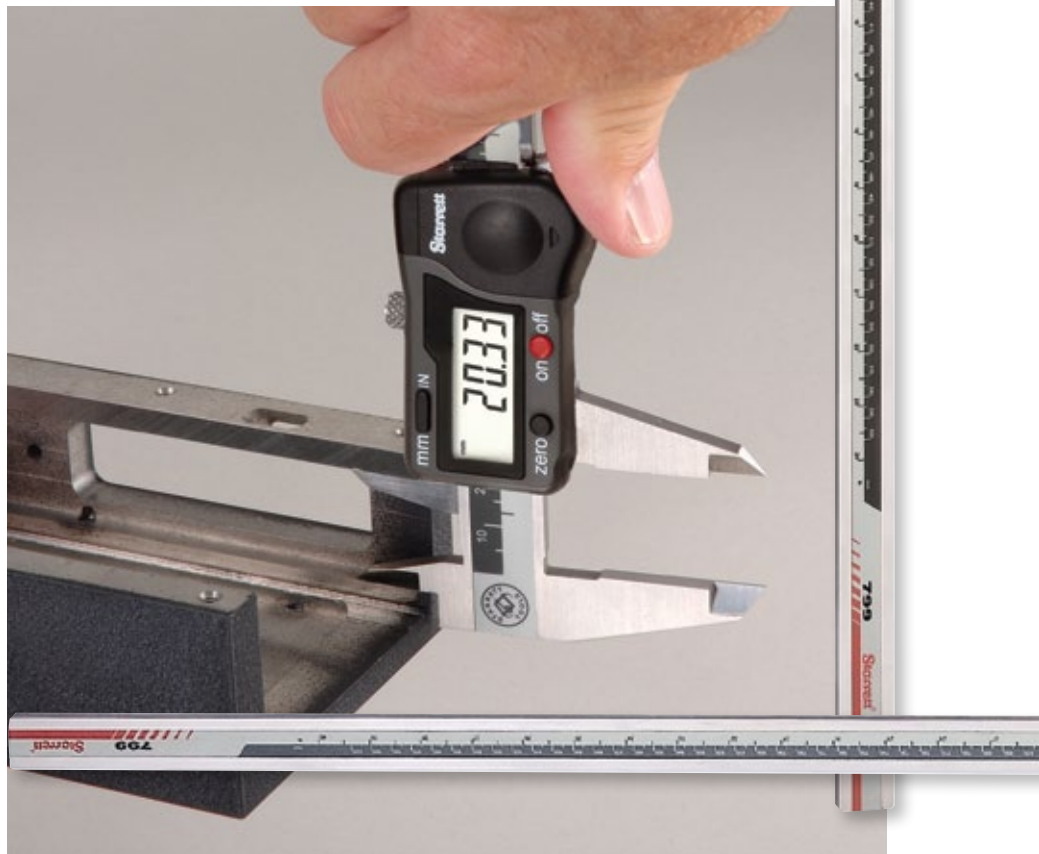





799 Electronic Calipers			
Range	Description	Cat. No.	EDP
150mm / 6"	Caliper in Fitted Plastic Case	799A-6/150	67410
200mm / 8"	Caliper in Fitted Plastic Case	799A-8/200	67412
300mm / 12"	Caliper in Fitted Plastic Case	799A-12/300	67621
600mm / 24"	Caliper in Fitted Plastic Case	799AZ-24/600	11978
1000mm / 40"	Caliper in Fitted Plastic Case	799AZ-40/1000	11979

  

Accessories and Case Information for 799 Electronic Calipers			
Description		Cat. No.	EDP
150, 200 & 300mm Calipers Only	Centre Distance Attachment	PT26151*	64440
	Depth Attachment	PT22431*	64640

\* Not Stocked

Approximate Jaw Depths for 799 Electronic Calipers					
	150mm	200mm	300mm	600mm	1000mm
Outside	38mm	50.8mm	63.5mm	100mm	150mm
Inside	16mm	19mm	18.3mm	17.46mm	17.46mm

799AZ-40/1000

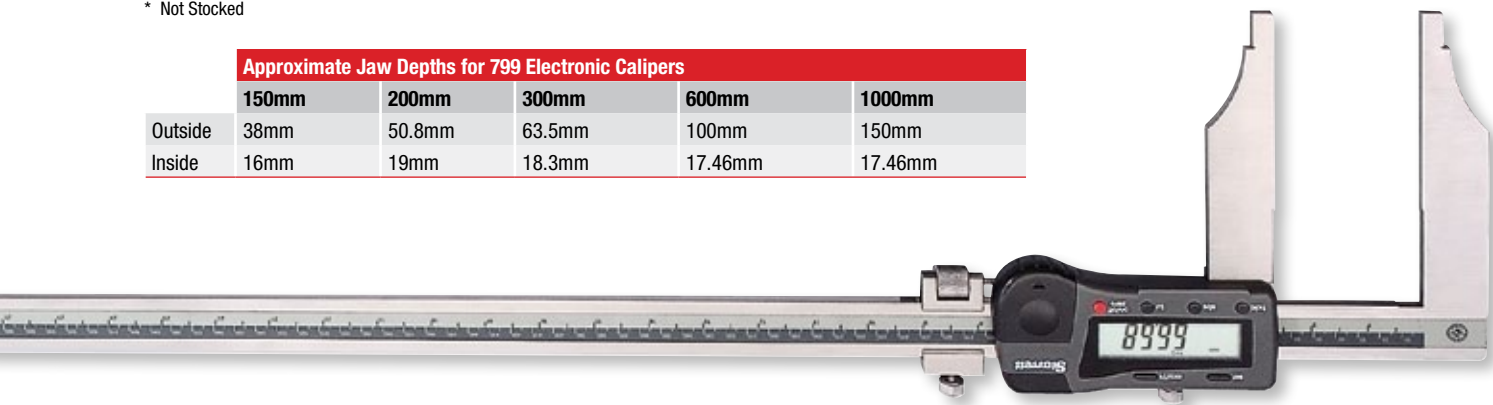



## 125 Vernier Calipers

0-300mm / 0-12"

- High quality, basic vernier caliper that offers metric and metric / imperial measurement
- Lock screw for sliding jaw
- Hardened stainless steel depth rod
- Sharp, black graduations on the satin finished bar



### 125 Vernier Calipers

Range	Graduations	Cat. No.	EDP
0-150mm	0.02mm	125MA-150	61880
0-150mm / 0-6"	0.02mm/0.001"	125MEA-6/150	61660
0-150mm	0.05mm	125MB-150	61881
0-200mm	0.02mm	125MA-200	61884
0-200mm / 0-8"	0.02mm/0.001"	125MEA-8/200	61882
0-200mm	0.05mm	125MB-200	61885
0-300mm	0.02mm	125MA-300	61888
0-300mm / 0-12"	0.02mm/0.001"	125MEA-12/300	61886
0-300mm	0.05mm	125MB-300	61889



## 1201 & 1202 Dial Calipers

0-300mm

With the ability to provide quick, accurate measurement of O.D., I.D. and depth, the dial caliper is the most versatile precision hand tool on the market.

1202 Dial Calipers are based on the caliper that has been the first choice of metal working professionals for decades. 1202 Dial Calipers are available in 150, 200 and 300mm versions.

Includes fitted case.

### Readability Features

- Sharp, clear dial graduations of 0.025mm with 2.54mm per revolution
- Sharp, black graduations on the satin finished bar, every 2.54mm

### Ease-of-Handling Features

- Knife-edge contacts
- Thumb-operated fine adjustment roll
- Adjustable bezel
- Lock screws for sliding jaw and dial bezel
- Covered rack depth rod (150 and 200mm models)

### Accuracy and Long-Life Features

- Hardened stainless steel bar, measuring surfaces, rack, gears and depth rod
- Positive, spring-loaded double pinion anti-backlash control

### 1201 Dial Calipers

Range	Graduations	Cat. No.	EDP
0-150mm	0.01mm	1201M-150	66962
0-200mm		1201M-200	66976

### 1202 Dial Calipers

Range	Graduations	Cat. No.	EDP
0-150mm	0.02mm	1202M-150	66963
0-200mm		1202M-200	66977
0-300mm		1202M-300	66978



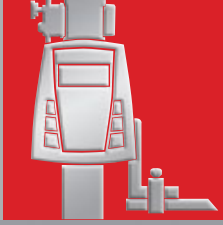

## Depth and Height Gauges



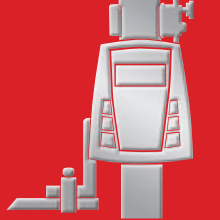

## 3753 Electronic Depth Gauges

0-300mm / 0-12"

The Starrett 3753 Electronic Depth Gauge is light and easy to use for depth measurements within its range.

### Readability Features

- Clear, easily-read numbers, properly sized for the tool

### Design Features for Accuracy and Long Life

- Linear accuracy:  $\pm 0.03\text{mm} / \pm .001''$
- Resolution:  $0.01\text{mm} / .0005''$
- Exclusive Starrett designed microprocessor chip
- Hardened stainless steel body and slide for long life
- Fine adjustment thumb roll for precision measurements
- Lock to hold the slide in position
- Hardened base is  $99\text{mm} / 3-15/16''$  long, but optional base extensions of 175 and 300mm / 7" and 12" are available. Spacing between holes is  $70\text{mm} / 2-3/4''$ .
- A hook attachment is furnished with the gauge, making it possible to take readings from the edge of a workpiece to edges of slots, grooves, shoulders, and other I.D. length dimensioning. The removable hook has the screw permanently attached to prevent loss.
- One-year minimum battery life with furnished 3-volt battery, CR2032



3753 shown with 3648-180 base extension attachment

### Action Features with Five Control Buttons

- Inch/millimetre conversion
- Zero at any position
- Hold readout at any position
- Manual ON/OFF plus a built in automatic OFF after 15 minutes of nonuse
- LIMITS button allows high and low limits to be set. Out-of-limits readings will show a flashing display.

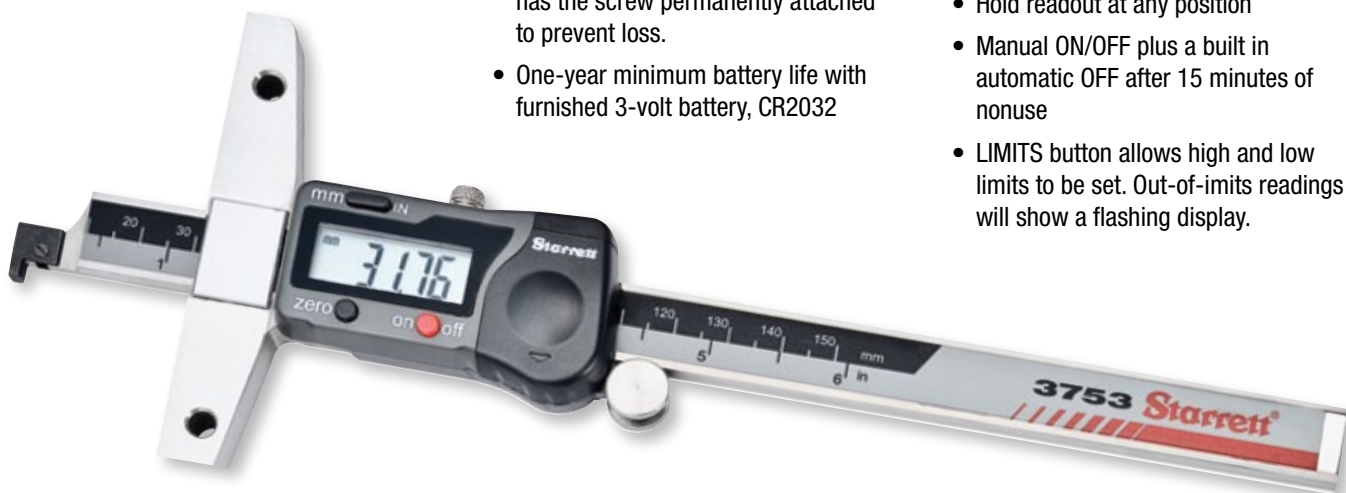

### 3753 Electronic Depth Gauges

Cat. No.	EDP	Description
3753A-6/150	12258	150mm/0-6" Range, Depth Gauge in Case
3753A-8/200	12259	200mm/0-8" Range, Depth Gauge in Case
3753A-12/300	12260	300mm/0-12" Range, Depth Gauge in Case

### Accessories for 3753 Electronic Depth Gauges

3648-180	12261	180mm Base Extension
3648-260	12262	260mm Base Extension
3648-320	12263	320mm Base Extension
PT99492*	65650	Two 3-Volt Batteries, CR2032

\* Not Stocked

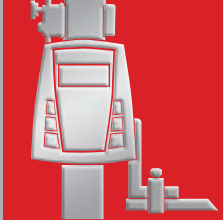

## 3751 Electronic Height Gauge

(without output)

150mm / 0-6"

This height gauge is light, portable and easy to use for vertical measurements within its range.

### Readability Features

- Easy-to-read LCD 8mm / .32" high characters

### Accuracy and Long Life Design Features

- Hardened, stainless steel bar for long life
- Fine adjustment thumb roll for precision measurements
- Rounded nose scriber cuts clean, sharp lines with smoothness and less pressure
- Lock to hold the slide in position
- Hardened, ground, and lapped base with finger grooves provides ease of movement
- Easy access to single long-life battery, 3-volt CR2032
- Vertical bar is back from the edge of the nose for better stability
- Scribe can reference zero from the bottom of the base to get the full 150mm / 6" usable range
- Linear Accuracy:  $\pm 0.02\text{mm}$  /  $\pm .001"$
- Resolution:  $0.01\text{mm}$  /  $.0005"$

### Action Features with Three Control Buttons

- Millimetre/inch conversion
- Zero at any position
- Manual ON/OFF plus a built in automatic OFF after 5 minutes of nonuse



#### 3751 Electronic Height Gauge

Cat. No.	EDP	Description
3751AZ-6/150	12221	Height Gauge, in Case

#### Accessories and Cables for 3751 Electronic Height Gauge

PT99492*	65650	One 3-Volt Batteries, CR2032v
947*	56756	Wood Case Only

\* Not Stocked

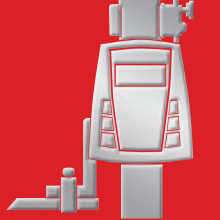

## 3752 Electronic Height Gauges

The 3752 Electronic Height Gauge is a full featured, versatile and economic solution for most height measurement applications.

All measuring information from these tools can be entered directly into Starrett Data Collection Systems for analysis, data collection and hard copy documentation. They are available in 0-300mm / 0-12" and 0-600mm / 0-24" ranges.

### Readability and Control Features

- Clear bar graduations in 5mm and .100" increments
- Large 9.65mm / .380", easy-to-read LCD display reads to 0.01mm / .0005"
- Instant millimetre/inch conversion
- Carrier and scriber designed to read from zero
- "Hold" control feature retains a reading at any position
- Plus or minus indication allows reading in proper direction
- Ability to set zero at any position
- Manual on/off plus a built-in automatic off after 30 minutes of nonuse

### Full Function Action Features

- Large positive action keypad
- Ability to retain and return to the true zero reading of the height gauge
- PRESET button to install any reading at any position
- Ability to install minimum and maximum limits
- RS232 data output port

### Battery Life

- 1-1/2+ years battery life. Two 3-volt batteries furnished (CR2450)

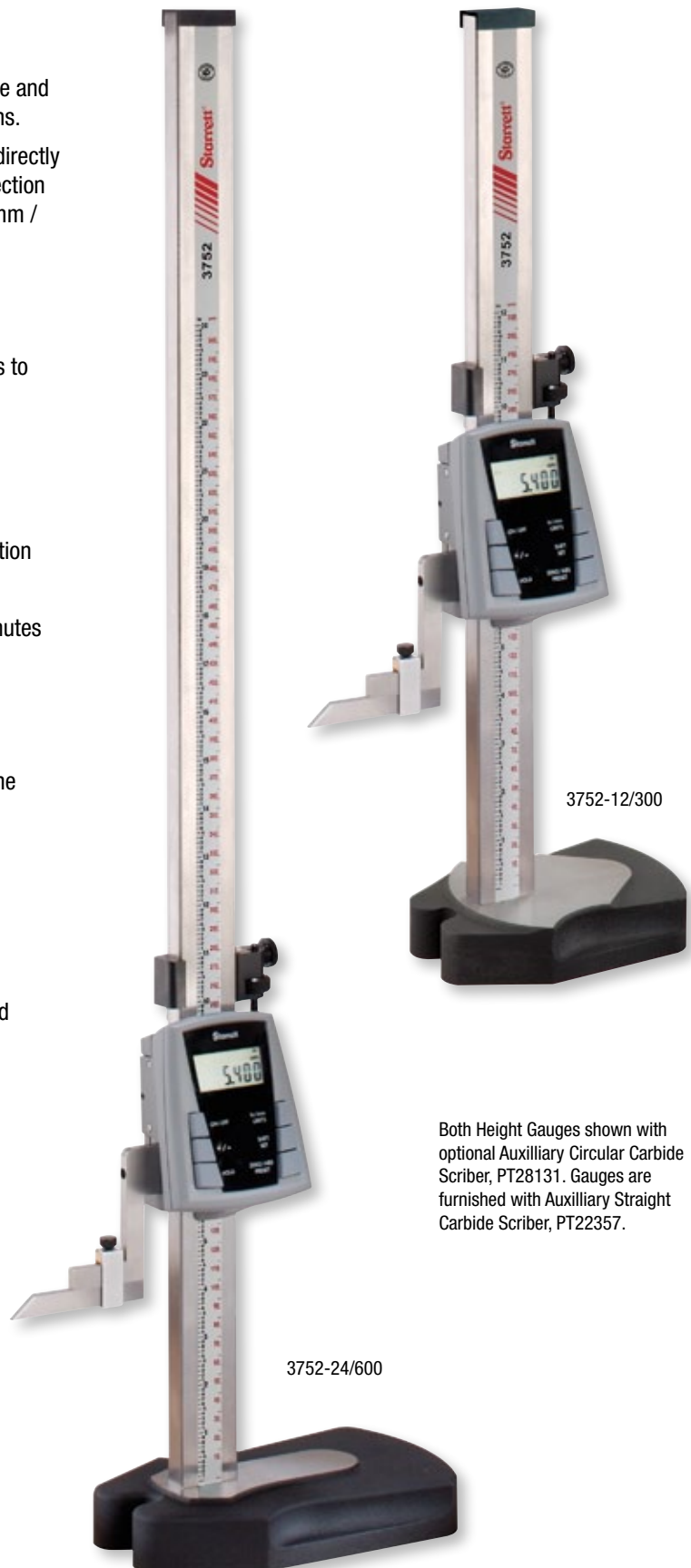

Both Height Gauges shown with optional Auxilliary Circular Carbide Scriber, PT28131. Gauges are furnished with Auxilliary Straight Carbide Scriber, PT22357.

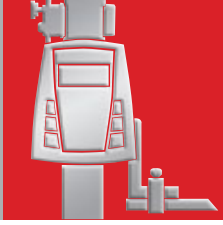

## Simple yet powerful gauge controls

**On/Off Button**  
(auto off after 30 minutes of nonuse)

**± Button**  
Toggles polarity or direction change

**Hold Button**  
retains current reading at any position



**Primary: mm/in**  
Toggles metric or inch readout

**Secondary: LIMITS**  
min/max tolerance specifications at any position

**Shift Set Button**  
Toggles between Primary & Secondary Functions

**Primary: ZERO/ABS**  
Toggles Zero at current position or absolute

**Secondary: PRESET Button**  
install any reading at any position



### 3752 Electronic Height Gauges

Range	Description	Cat. No.	EDP
0-300mm/0-12"	Height Gauge without Case	3752-12/300	68815
0-600mm/0-24"		3752-24/600	68816

### Cables, Accessories, Cases for 3752 Electronic Height Gauges

Description	Cat. No.	EDP
Shielded Cable to Starrett 761/772 Series Modules, PT61768 Adaptor	PT22938*	64059
Interface Adaptor for Starrett Tools to PC	PT61768*	66454

\* Not Stocked

### Specifications for 3752 Electronic Height Gauges

<b>Resolution</b>	0.01mm / .0005"
<b>Graduations</b>	5mm / .100"
<b>Overall</b>	.04mm / ±.0015" 0-450mm / 0-18" Accuracy .05mm / ±.002" 450-600mm / 18-24"
<b>Battery Life</b>	Over 1-1/2 Years Average Use

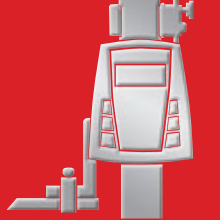

## 2000 Altissimo® Electronic Height Gauge 0-24" / 600mm

Altissimo® Electronic Height Gauges are innovative, easy-to-use, and loaded with Starrett-exclusive functions for easy-to-program measuring routines that run smoothly and reliably.



### Features

- A unique, ergonomically shaped base, hardened and ground, that fits your grip just right to easily move the gauge and press the hot key
- Hot key allows you to select measuring results on the fly
- 0-24" Measuring Range
- Smart probe that can measure I.D. or O.D. without attachments
- Electronically adjusted probe force
- Large, easy-to-read interactive LCD with unique scanning metre for monitoring probe position
- Electronically adjustable beeper volume
- Bold screen icons indicate the current routine
- Three electronically adjustable resolutions
- Retains the last calibrated diameter of the measuring probe, even after the gauge is shut down
- Dynamic bi-directional probing with point and scan modes
- Easy operation with speed wheel, which also has fine-adjust feature
- Locking mechanism for scribing
- Five measurement modes: (ID/OD, Centre, TIR, Max/Min, Continuous Display)
- Instant inch/millimetre conversion
- Two selectable Datums and Preset
- Auto Power Off after two hours with retention of probe calibration
- Automatic calculation of eight measurement routines:
  - Centre
  - Diameter
  - Height
  - Max
  - Min
  - TIR
  - Distance to last feature
  - Distance between last two points
- Rechargeable NiMH batteries with 100 hours of continuous life
- Seven setup functions:
  - Probe Calibration (2)
  - Beeper Volume
  - Display Resolution
  - Probe Force Adjustment
  - Printer On/Off
  - Force Calibration
- Optional probe kit features a variety of probes for many applications
- Gauges include carbide probe, probe holder and probe calibration block
- RS232 data output port
- Starrett capacitive measurement system ensures the accuracy and reliability you expect
- Excellent value – loaded with features and competitively priced

### Specifications:

<b>Measuring Range</b>	600mm/24" (Extendible to 30"/750mm by rotating the probe holder 180°)
<b>Resolution</b>	.002mm/.01mm/.02mm (.0001"/.0005"/.001")
<b>Accuracy</b>	±.008mm (±.0003")
<b>Repeatability</b>	±.002mm (±.0002")
<b>Power Source</b>	NiMH Rechargeable Batteries (120V AC/60Hz Charger/Adaptor included). Operation time: 100+ hours, Recharging time: 10 hours
<b>Included</b>	4.8mm (.1875") Dia. Carbide Probe, Probe Holder
<b>Accessories</b>	AC Charger/Adaptor, Probe Calibration Block
<b>Dimensions</b>	Length 279mm (11"), Width 197mm (7-3/4"), Height 927mm (36-1/2")
<b>Weight</b>	18 kg (40 lb)
<b>Perpendicularity</b>	0.010mm (.0004")



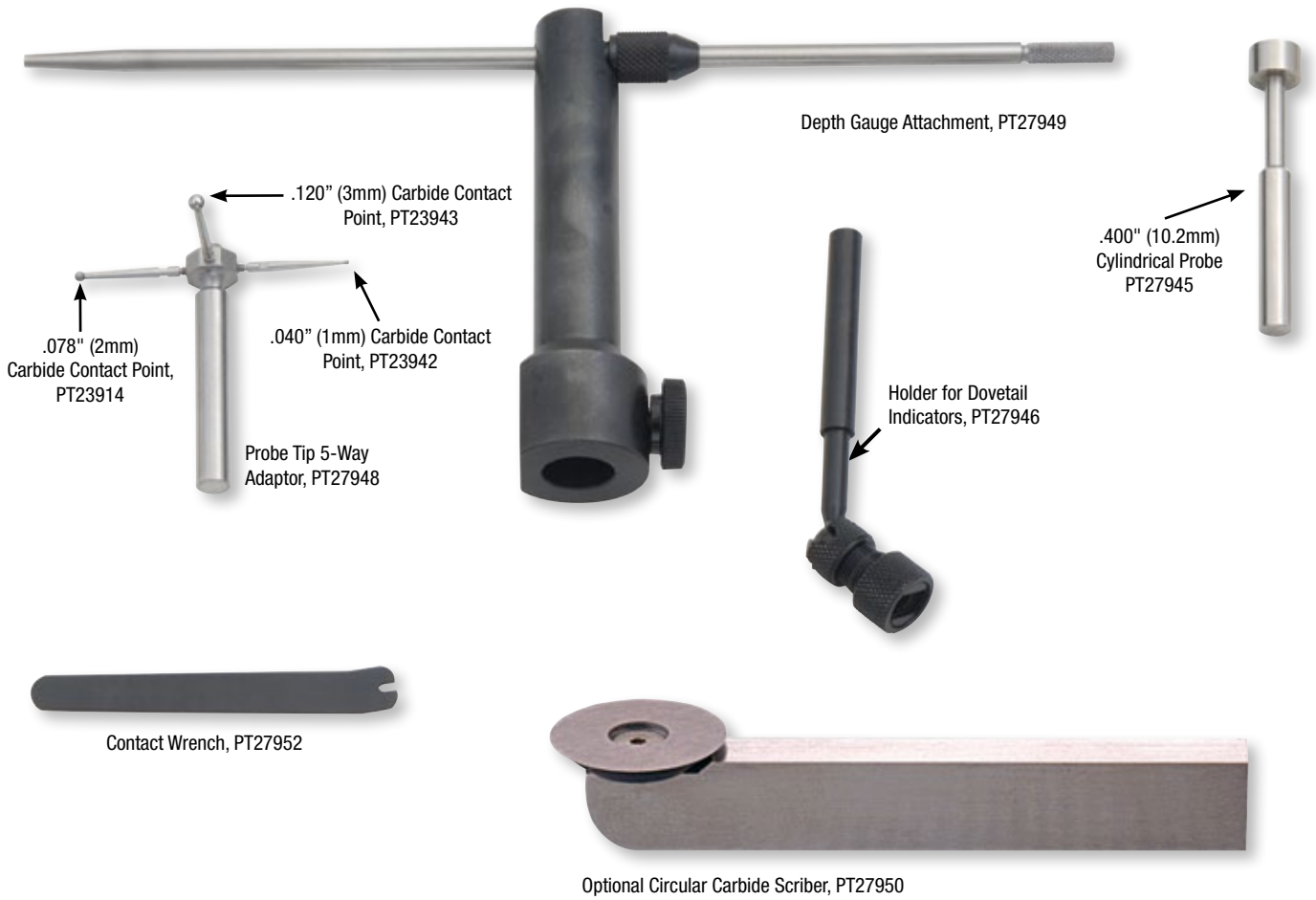
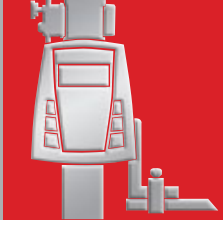

### Altissimo® Electronic Height Gauges with Standard Components

Description	Cat. No.	EDP
Height Gauge	2000-24*	67008
Carbide Probe 4.8mm (.1875") Dia. (Standard)	PT27937*	67009
Probe Holder (Standard)	PT27940*	67010
Probe Calibration Block (Standard)	PT27944*	67011
<b>Accessories for Altissimo® Electronic</b>		
Accessory Set Includes:	S2000AZ*	66997
Probe Tip, 5-Way Adaptor	PT27948*	67012
1mm (.040") Carbide Contact Point	PT23942*	65255
2mm (.078") Carbide Contact Point	PT23914*	64222
3mm (.120") Carbide Contact Point	PT23943*	65256
Contact Wrench	PT27952*	67013
10.2mm (.400") Cylindrical Probe	PT27945*	67014
Circular Carbide Scriber	PT27950*	67015
Depth Gauge Attachment	PT27949*	67016
Holder for Dovetail Indicators	PT27946*	67017
Replacement Battery Pack, NiMH 6V	PT62011*	67018
Power Supply Charger for United Kingdom Configuration	PT62130*	67003
Power Supply Charger for European Configuration	PT62131*	67004
Shielded Cable to Starrett 761/772 Series Starrett Modules and PT61768 Adaptor	PT62103*	67019

\* Not Stocked

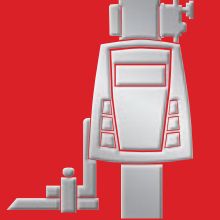

## 3259 Dial & Digital Height Gauges

### Accurate, Easy & Economical

Starrett 3259 Height Gauges combine a large dial indicator with two dual direction mechanical digital counters that register travel in both directions.

Zero can be set anywhere within the range of travel.

### Features & Specifications

- Large knob for coarse and fine adjustment
- Dual stainless steel beams
- Zero/reset button located on the digital counter
- Carbide tipped scriber and clamp
- Locking lever
- Hardened and ground base lapped for flatness
- Accuracies:
  - 0-200mm:  $\pm 0.025\text{mm}$
  - >200-300mm:  $\pm 0.04\text{mm}$
  - >300-600mm:  $\pm 0.05\text{mm}$



#### 3259 Dial & Digital Height Gauges & Accessory

Description	Range	Cat. No.	EDP
Dial Height Gauge	0-300mm	3259M-300	12570
w/directional digital counters	0-600mm	3259M-600	12580
Holder for indicator attachments		3259-AC	69909

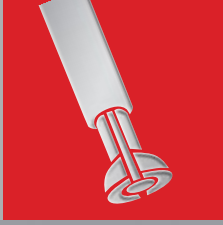

# Hole and Slot Gauges





## Small Hole Gauges

3.2-12.7mm

829 small hole gauges are full-ball gauges used for general work.

831 small hole gauges have a half-ball gauging surface with a flat bottom. This permits use in even the most shallow holes, slots, and recesses.



### Small Hole Gauges

Features:

- Hardened-ball measuring surface with two-point contact
- Radius on each gauge is less than the minimum diameter to be measured, which provides the two-point contact necessary for maximum accuracy
- Smooth, sensitive adjustment for better feel, giving more accurate measurements
- The adjustment of the gauge beyond maximum range is restricted by a safety stop that prevents breakage

Accurate measurements are obtained by slightly “rocking” these gauges in the hole to be measured. This will guarantee contact at the true diameter. The final size is then obtained by measuring over the ball contacts with a micrometer.

#### 829 Small Hole Gauge Set

Description	Cat. No.	EDP
Set of 4 in Case: 829A: 3.2-5.1mm, 75mm long 829B: 5.1-7.6mm, 80mm long 829C: 7.6-10.2mm, 85mm long 829D: 10.2-12.7mm, 90mm long	S829EZ	53074

#### 831 Small Hole Gauge Set

Set of 4 in Case: 831A: 3.2-5.1mm, 70mm long 831B: 5.1-7.6mm, 80mm long 831C: 7.6-10.2mm, 85mm long 831D: 10.2-12.7mm, 90mm long	S831EZ	53087
--	--------	-------

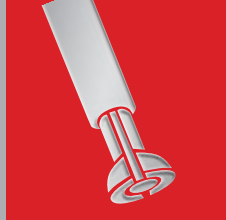

## 579 self-centering telescoping gauges with two telescoping arms

8-150mm

- Two telescoping contacts
- Handles are rigidly attached to the contact plungers and are automatically self-centring
- Constant spring tension gives uniform contact pressure
- Both plungers are easily locked at any desired setting



### 579 Telescoping Gauge Sets

Description	Cat. No.	EDP
Set of 4 in Case: 579A: 8-13mm, 60mm long 579B: 13-19mm, 60mm long 579C: 19-32mm, 60mm long 579D: 32-54mm, 60mm long	S579GZ	52616
Set of 6 in Case: 579A: 8-13mm, 60mm long 579B: 13-19mm, 60mm long 579C: 19-32mm, 60mm long 579D: 32-54mm, 60mm long 579E: 54-89mm, 60mm long 579F: 89-150mm, 82mm long	S579HZ	52617



## 3089 Dial Bore Gauges

Starrett 3089 Dial Bore Gauges offer precision, a full compliment of features and excellent value.

### Features

- Non-slip insulating grip
- Carbide contacts for extended wear
- Aluminum case with gauge and accessory cutouts
- Gauge chart for quick and easy anvil selection
- 2-point contact
- 0.01mm graduations



### 3089 Dial Bore Gauges

Range	Probe Depth	Contacts	Spacers	Extension	Cat. No.	EDP
6-10mm	40mm	8	-	-	3089M-181-10J	12199
10-18mm	100mm	9	0.5	-	3089M-181-18J	12200
18-35mm	125mm	9	0.5 & 1mm	-	3089M-181-35J	12201
35-50mm	150mm	4	0.5, 1, 2 & 3mm	-	3089M-181-50J	12202
50-160mm	150mm	12	0.5, 1, 2, 3 & 6mm	-	3089M-181-160J	12203
160-250mm	400mm	5	-	55mm	3089M-181-250J	12204
250-450mm	400mm	5	0.5, 1, 2, 3 & 6mm	50 & 100mm	3089M-181-450J	12205
18-160mm	125-150mm	9, 4, 12	-	50mm	S3089MZ-181-160J	13015



## Dial and Electronic Indicators Gauges





## AGD Group 2 2900 Electronic Indicators

### Innovative, Full Featured & Tough

2900 Electronic Indicators are available in a choice of configurations to meet a range of requirements. Innovative True Absolute Sensor Technology minimizes the chance of data loss for exceptional reliability. Built with IP67 protection and customary Starrett quality, they maintain their reliability in hostile shop environments.

### Features

- True Absolute Sensor Technology – remembers position and zero set point even during battery replacement. Cannot be “over-spiced” into failure.
- Intuitive design and layout – easy to learn and use
- Positive, tactile-feel button activation
- IP67 protection against dirt, dust water and coolant to withstand hostile shop environments
- Long battery life
- External power supply not required
- CE compliant
- Data output on all models
- Choice of Basic, Standard and Advanced feature levels
- One micron resolution available
- Selectable resolution models available
- Variable ratio measurement systems available



2900-6M

Features by Model	3-Button Basic	6-Button Standard	6-Button Advanced
Origin Set, Zero Set	X	X	X
Counting Direction Switching (+/-)	X	X	X
Power ON/OFF	X	X	X
Inch/mm conversion (n/a Metric only)	X	X	X
Data Output	X	X	X
Limit Set		X	X
Value Preset		X	X
Reading Hold		X	X
Selectable Resolutions (as indicated)		X	X
Feature Lock		X	X
Max/Min/Runout Value Holding			X

### 2900 Electronic Indicators & Accessories

Description	Resolution	Range	Cat. No.	EDP
3-button Basic Metric indicator	.001 mm	12mm	2900-1M	09986
6-button Standard Metric indicator with Selectable Resolution	.01 mm / .001 mm	12mm	2900-4M	09988
6-button Advanced Metric indicator with Selectable Resolution	.01 mm / .001 mm	12mm	2900-6M	09990
Two CR2032 batteries			PT99492	65650





## AGD Group 2

### 3600 Electronic Indicators

Ranges up to 12.7mm

3600 Electronic Indicators have simple, powerful, easy-to-use functions, all at an attractive price. Versions are available for inch/metric and metric only.

#### Features

- Large, easy-to-read LCD
- Range: 12.7mm / .500"
- Resolution: .01mm / .0005"
- Power On / Off button
- Reverse travel ( $\pm$  control indicates direction)
- Zero setting at any position
- Long battery life
- 8mm diameter stem
- M2.5 X .45 thread
- Lug-on-centre back with additional flat back
- Dust cap
- Plastic storage case with clear cover



#### 3600 Indicator

Range	Resolution	Cat. No.	EDP
12.7mm	0.01mm	3600M-5	68918



3025-481



3025-257J



3809MAC

## 3025 & 3081 Dial Indicators

- Tolerance hands and bezel lock
- Long life jewel bearings
- Lug-on-centre back

## 3808 & 3809 Dial Indicators

- Precision gear-driven design
- Reversible contact point direction
- Multiple dovetail locations
- Include dovetail clamps for 4mm & 9.5mm post



Dovetail Clamp with 4mm Post



Dovetail Clamp with 9.5mm Post

- Additional accessories included with 3808MAC & 3809MAC indicators:



Swivel Post Snug with Dovetail Indicator Clamp



1mm Ball Contact



2mm Ball Contact



Contact Point Wrench



Tool Post Holder

### 3025 & 3081 Dial Indicators

Cat No.	EDP	Range	Grad.	Dial Reading
3025-257J	66601	1mm	0.001mm	0-200
3025-481	61961	10mm	0.01mm	0-100
3025-481/5	66296	5mm	0.01mm	0-100
3025-681	12314	20mm	0.01mm	0-100
3081-481/5	66504	5mm	0.01mm	0-100

### 3808 & 3809 Dial Indicators

Cat No.	EDP	Range	Grad.	Dial Reading
3808MA	12332	0.2mm	0.002mm	0-100-0
3808MAC*	12304	0.2mm	0.002mm	0-100-0
3809MA	12334	0.8mm	0.01mm	0-40-0
3809MAC*	12307	0.8mm	0.01mm	0-40-0

\* Includes two additional contacts and wrench, swivel post snug with dovetail indicator clamp, and tool post holder.



196MB1

## 196M Universal Back Plunger Dial Indicators

5mm

- Accurate and reliable
- Simple to operate
- Rugged, with few moving parts
- Smooth in operation
- 0.02mm graduations
- 6.3mm shank diameter

For full use, the operator first chooses the proper contact from the three hardened contact points that come with each model. The contact should then be brought against the work with enough pressure to give the hand one full turn. Set the hand at zero by rotating the dial with the knurled bezel. This provides one full rotation of the hand both to the right and left of zero, showing a rise or drop in the work and the amount of that variation.



196R, 196MR

PT05471

PT05472

PT05473

### Contact Points and Adaptors Only for 196 Universal Back Plunger Dial Indicators

Description	Cat./Part No.	EDP
Adaptor**	196R*	50711
Adaptor (Metric Threads)	196MR*	67457
	PT05471*	70617
Hardened Steel Contact Point	PT05472*	70618
	PT05473*	70619

\* Not Stocked

\*\* For Contact Points with #4-48 Thread, see AGD Contact Listings.

### 196 Universal Back Plunger Dial Indicators (6.3mm Shank Diameter)

Grad.	Range	Dial Reading	Description	Cat No.	EDP
0.02mm	5mm	0-100	Indicator with 3 Contact Points, Adaptor, 4 Attachments*** in Case	196MA1Z	65251
		Yellow Dial Face	Indicator with 3 Contact Points and Adaptor Only	196MB1	65252
		0-50-0	Indicator with 3 Contact Points, Adaptor 196R, 4 Attachments*** in Case	196MA5Z	65253
		Yellow Dial Face	Indicator with 3 Contact Points and Adaptor Only	196MB5	65254

\*\*\* Attachments include clamp, tool post holder, snug and hole attachment.



**653 Dial Gauge Stands**  
with Cast iron base

These bench-type comparator stands are ruggedly built for in-process and final inspection work.

The dial indicator can be adjusted vertically and locked in any position. A sliding ring with locking screw below the beam permits swinging the indicator to either side. The ring also acts as a safety device, preventing the beam from accidentally dropping. There is a fine adjustment on the beam for final indicator setting.

The hand lifting lever on the indicator raises the spindle and releases it to contact the work. Left hand lever furnished unless otherwise specified.

Maximum vertical capacity of 235mm and a throat depth of 125mm and a vertical indicator fine adjustment of up to 12.7mm. Post diameter is 38.1mm.

653 has a precision ground cast iron base measuring approximately 200 x 225mm.



**660 Magnetic Base Indicator Holder**  
with triple jointed arm

The compact and versatile 660 magnetic base indicator holder has three adjustable pivots controlled by a single knob for fast, easy indicator positioning.

- Small but powerful magnetic base with 320N holding force
- Positive On/Off switch
- Base Dimensions: 30mm x 40mm x 35mm
- Horizontal and vertical mounting positions
- Will hold any indicator with a 9.5mm stem or standard dovetail mount
- Articulating arm with powerful central locking knob, provides full 360° horizontal positioning and over 180° vertical positioning
- Maximum Horizontal Reach: 120mm; Maximum Vertical Reach: 190mm
- Very sensitive fine-adjustment thumb screw

**653 Cast Iron Dial Gauge Stand**

Graduation	Cat. No.	EDP
Gauge Stand with Cast Iron Base, without Indicator	653	55917

**660 Magnetic Base Indicator Holder**

Description	Cat. No.	EDP
Base Indicator Holder	660	68621



## 661 Mini Magnetic Indicator Holder

The Starrett Mini Magnetic Tool Holder is a simple, versatile, effective and economical tool for a variety of indicator holding tasks. It has no levers or switches – simply place the holder on the measuring surface, attach the indicator and position as required.

### Features & Specifications

- 133N holding force
- Base Diameter: 30mm
- Base Height: 25.4mm
- Overall Height 106mm
- Holds indicators with 9.5mm stems or standard dovetail mounts
- Fits over spindles and posts with diameter of 6.3mm, such as the Starrett 196 Dial Indicator
- Includes an 8mm adapter



## 3657 Magnetic Indicator Holders

- Accommodates all Starrett test, back-plunger, AGD, dial and miniature-dial indicators as well as similar indicators from other manufacturers
- Fine adjustment
- Positive On/Off switch

661 Mini Magnetic Indicator Holder		
Description	Cat. No.	EDP
Indicator Holder	661	68620

Cat No.	EDP	Description
3657AA	68849	Magnetic Base with attachments: Upright Base Post, Snug, Rod, Indicator Attachment
3657MTW	12696	Magnetic Base Flex O Post Indicator Holder



## 1015M Portable Dial Thickness Gauges

0-25mm

After inserting work between the measuring contacts, releasing the lever will cause the spindle to contact the work, giving an accurate size reading because measuring pressure is independent of the user. Indicators have jewel bearings and continuous dials. (Models with balanced dials, other graduations and ranges are also available on special order. Electronic indicators can also be supplied.) The contact edges are radiused to prevent the work from being marred or deflected. The flat contact area measures 6.3mm in diameter and is 0.125mm thick. Special contact sizes and shapes are available by request.

## 3015MA Portable Dial Thickness Gauge

- Precision ground contacts
- Jeweled bearings
- Ergonomic grip

**Portable Dial Thickness Gauges, Millimetre Reading**

Throat Depth	Range	Graduation	Dial Reading	Dial Indicator Model No.	Cat. No.	EDP
100mm	10mm	0.01mm	0-100	1015MA-481J	1015MA-100	67647
66mm				-	3015MA	11661



## 1175M Dial Indicator Groove Gauges

9.5-150mm

This lightweight gauge is used for in-process or bench inspection of oil grooves, snap ring retainer grooves, "O" ring seat retainer grooves and similar internal recesses. It is also useful for checking bore dimensions and testing for taper, bell-mouth and out-of-roundness.

The movable, sensitive gauging contact has a 12.7mm retractable range and transfers the measurement through a linear, friction-free transfer mechanism to the dial indicator. The lower reference jaw is fixed and supports the entire weight of the gauge and the operator's hands, thus preventing incorrect gauging pressure and false readings.

The reference jaw can be mounted in two positions on the range adjusting bar. The bar itself is also adjustable for greater or lesser range. A fine adjustment screw and a lock are also provided.

### Features:

- Supplied with two sets of jaws, both readily interchangeable
- Three sets of contacts are furnished that can be attached to the ends of the jaws without replacing the entire jaw. Contacts have flush ends so that grooves at the bottom of blind holes can be gauged. The contacts are hardened steel with a hard chrome finish for long life
- Gauge can be set with gauge blocks or other methods such as micrometers, vernier calipers and ring gauges
- Furnished with storage case

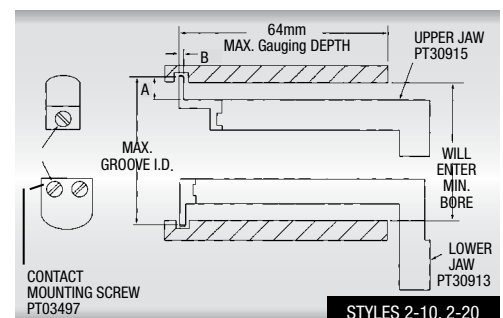
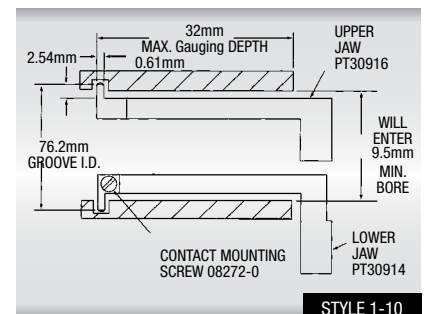

### 1175 Dial Indicator Groove Gauges

Range	Dial Indicator Model No.	Graduation	Reading	Range	Cat. No.	EDP
9.5-150mm	81-181-1175	0.01mm	±100	2.5mm	1175MZ	65032

### 1175 Dial Indicator Groove Gauge Contact Sets

Contact Set	Upper Part No.	Upper Part EDP	Lower Part No.	Lower Part EDP	Will Enter Minimum Bore	Maximum Groove I.D.	Minimum Groove Depth	Minimum Groove Width
Style 1-10	PT30917*	71745	PT30917*	71745	9.5mm	75mm	2.5mm	0.6mm
Style 2-10	PT30918*	71746	PT30919*	71747	17.5mm	125mm	3.6mm	0.8mm
Style 2-20	PT30920*	71748	PT30921*	71749	25mm	150mm	6.7mm	1.3mm



## 696 Crankshaft Distortion Dial/Strain Gauge

61–458mm

Ideal gauge for checking bearing alignment or shaft deflection without dismantling the engine. Also useful as a strain gauge on engine frames. This inside measuring gauge checks the distortion of crankshaft webs and bears a direct relation to existing misalignment or excessive bearing wear. Used on all diesel engine shafts and centre crankshafts on any type of engine or compressor, the gauge can also be applied as a strain gauge on engine frames while the engine is operating. A comparison of readings taken at top and bottom positions indicates any misalignment of cylinder and frame which results in local over-stress and eventual cracking of the frame neck.

With a special spring tension in the dial indicator, the gauge is self-sustaining in any position without sacrificing necessary rigidity, leaving the operator's hands free. Hardened and ground to a sharp point, conical contact points have an approximate 60° included angle, and will stay in place on 45° surfaces.

**696B Balancing Attachment** is furnished with the gauge. For certain applications, like turning the crank under test with the gauge in place, the attachment can be adjusted to maintain the face of the indicator upward or in desired position. To install on a strain gauge in use, remove the knurled clamping nut, then the doweled plate or end strap at either end by the screw. The unit is then positioned over the hubs on two sides of the indicator head. A spring plunger provides the friction that holds the balance in proper relation to position. The parts are nickel plated.

The dial indicator movement is approximately 4mm and with rods and extension, provides a range from 61-458mm. There are 10 rods and one extension furnished. Rods are marked to designate the approximate overall length of the gauge. Indicator has a movable bezel to adjust the dial in relation to the hand and a non-breakable crystal.



696B Balancing Attachment

Designed in collaboration with Hartford Steam Boiler Inspection and Insurance Company. It was known as the Hartford Steam Boiler Engine Strain Gauge and is used by their inspectors to check the distortion of engine shafts and frames.

### 696M Crankshaft Distortion Dial/Strain Gauges

Range	Dial Indicator		Range One Rev.	Description	Cat. No.	EDP
	Graduation	Dial Reading				
61-458mm	0.02mm	0-50-0	1mm	Millimetre Strain Gauge with Balancing Attachment	696MZ	52902

Gauge furnished with 10 rods, sharp points and balancing attachment in attractive, protective case.





FIG. 1

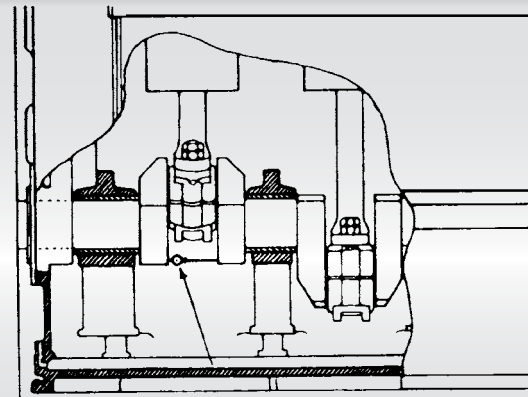

STRAIN GAUGE APPLIED TO CRANK OF DIESEL ENGINE TO DETERMINE IMPROPER ALIGNMENT.

FIG. 2

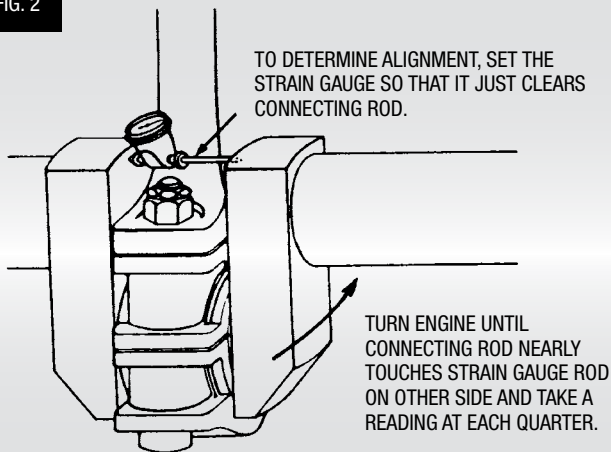
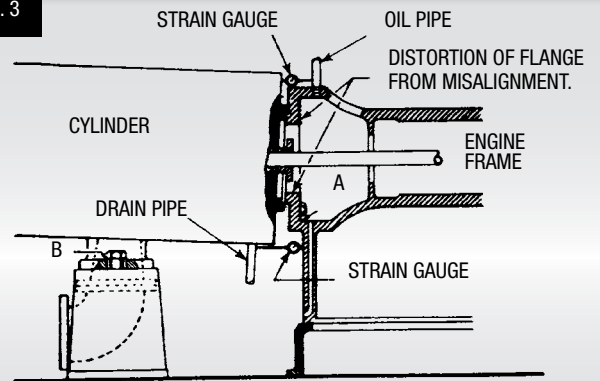
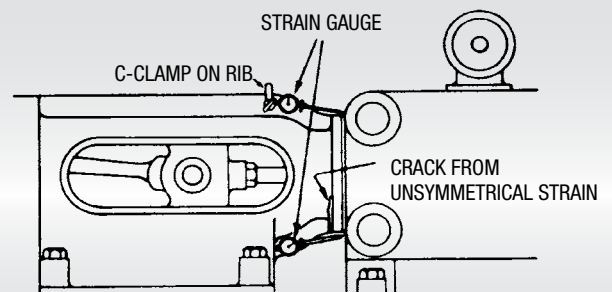

FIG. 3



MISALIGNMENT OF CYLINDER AND ENGINE FRAME (SHOWN EXAGGERATED FOR PURPOSES OF ILLUSTRATION).

FIG. 4



STRAIN GAUGE APPLIED TO ENGINE FRAME (WHILE OPERATING), DIFFERENCE BETWEEN TOP AND BOTTOM READINGS OF THE STRAIN GAUGE INDICATES IMPROPER ALIGNMENT, CAUSING CRACKS.



## 649 Spindle Square™

The Starrett 649 Spindle Square offers accuracy, convenience and significant time saving with the common shop task of trammung the head of a vertical milling machine. This must be done regularly to ensure squariness and perpendicularity between the spindle and work surface.

The spindle square is easier to use and more precise than the traditional method of trammung with a dial test indicator.

### Using the Spindle Square

After setting the spindle square indicators to “0” on a surface plate, place the Spindle Square into the collet of the milling machine and bring the head down to the table until both indicator needles have rotated approximately one full rotation.

The needles do not need to point in the same direction. Identical numerical readings, not the needle positions, indicate squareness.

To tram the milling machine, adjust the machine per normal procedures until both indicators read the same numerical value. After setting the X-axis, repeat the same procedure with the Y-axis.

### Features & Specifications

- Fully assembled with two AGD Group 2 dial indicators
- Patented design
- Solid steel body construction with durable black oxide finish
- Ground gauging surface
- Approximately 1.8kg with custom case
- 9.5mm shank diameter
- 100mm between contact points
- Approximately 172mm wide and 140mm from the top of shank to the end of the contact points



649 Spindle Square

Range	Graduation	Dial Reading	Cat. No.	EDP
2.5mm	0.01mm	0-50-0	649-1M	52082

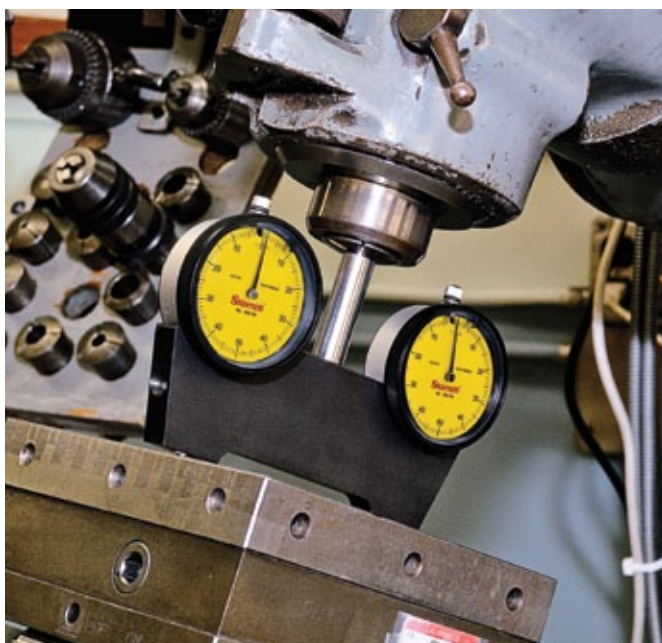



## Hardness Testers Surface Testers



## 3814 Analogue Bench Hardness Tester

The 3814 Hardness Tester provides reliable Rockwell Hardness values on all types of metal and alloys, hard or soft, and in many shapes. This reliable bench hardness tester has a high quality casting, is ergonomically designed for easy operation and is engineered to ensure accurate results.

It is an ideal basic hardness solution, economically priced to suit a variety of lab, workshop, toolroom and inspection department applications. The 3814 conforms to ASTM E-18 standard.

The tester is furnished with a diamond indenter, a 1.6mm (1/16") ball indenter, three certified test blocks, four test tables – 149mm (5.87") and 63.5mm (2.5") flat anvils, 15.9mm (5/8") spot anvil and a standard vee anvil – and an accessory case.

### Features

- Ability to handle Rockwell Scales A through H and K
- Stable cast iron construction
- Ideal basic hardness testing for many typical applications



### Specifications for 3814 Analogue Bench Hardness Tester

Minor Load	10Kgf
Major Load	A: 60Kgf, B: 100Kgf, C: 150Kgf
Test Force Application	(Dead weight applies test force)
Test Force Control	Hydraulic Dashpot System
Results Display	Analogue – Dial Gauge
Throat Depth	168mm (6.6")
Maximum Test Height	169.9mm (6.69") **
Unit Height/Width/Depth	762 x 216 x 508mm (30 x 8.5 x 20")
Unit Weight	121kg (267lb)

### 3814 Analogue Bench Hardness Tester

Description	Cat. No.	EDP
Analogue Hardness Tester	3814*	67754
Hardness Tester Stand	PT06145*	72519

### Accessories\* for 3814 Analogue Bench Hardness Tester

"C" Regular	PT05245*	67944
1.6mm (1/16") Ball Unit	PT05249*	67948
RA Test Block (Rockwell A Scale 80)	PT05069*	67897
RB Test Block (Rockwell B Scale 90)	PT05059*	67888
RC Test Block (Rockwell C Scale 63)	PT05050*	67879
Master Block Set, Rockwell C Scale	PT05272*	67969

\* Not Stocked

\*\* Requires bench alteration.



## 3815 Twin Analogue Bench Hardness Tester

### Measures Rockwell & Superficial Rockwell Hardness

The Starrett 3815 Twin Analogue Hardness Tester features state-of-the-art design and rugged construction. It is engineered to provide highly sensitive, accurate readings and excellent repeatability in all Rockwell and Superficial Rockwell hardness scales.

The 3815 is ideal for heat treatment facilities, tool rooms, workshops, laboratories and inspection labs.

### Features

- Direct analogue dial reading
- Advanced design provides Rockwell and Rockwell Superficial testing
- Easy to operate
- Engineered to provide highly sensitive and accurate readings
- Conforms to ASTM E-18
- Tests Rockwell Scales: A, B, C, D, E, F, G, H, K, L, M
- Tests Superficial Rockwell Scales: HR15N, HR15T, HR30N, HR30T, HR45N, HR45Ts
- Includes a diamond conical indenter, 1/16" ball indenter, HRC, HRB, HR15N, HR30N and HR45T test blocks, 5.87" (150mm) test table, 2.5" (63mm) flat anvil, standard vee anvil, accessory case and dust cover
- A broad range of test blocks and other hardness tester accessories are available.



### Specifications

Minor Load	10 Kgf
Minor Load – Superficial	3 Kgf
Major Load	60/100/150 Kgf
Major Load – Superficial	15/30/45 Kgf
Test Force Application	Dead Weight
Test Force Control	Manual
Results Display	Dual Scale Dial
Vertical Capacity	15.2mm (6.0")
Throat Depth	14mm (5.5")
Height	66mm (26.0")
Width	46.2mm (18.2")
Depth	23.9mm (9.4")
Weight	113kg (250 lbs)

### 3815 Twin Analogue Bench Hardness Tester

Description	Cat. No.	EDP
3815 Bench Hardness Tester, diamond conical and 1.60mm (1/16") ball indentors, HRC, HRB, HR15N, HR30N and HR45T test blocks, 150mm (5.87") test table, 64mm (2.5") flat anvil, standard vee anvil, accessory case and dust cover	3815*	12800
Hardness Tester Stand	PT06145*	72519

\* Not Stocked



Includes base instrument, impact device D, calibrated test block, custom carry case, cleaning brush and operation manual



## 3811A Compact Hardness Tester

The Starrett 3811A is a state of the art, digital portable hardness tester, designed to test the hardness of large, hard metal parts.

The 3811A combines fast test speeds with ample memory and output. It performs tests that easily convert to most popular hardness scales such as Rockwell, Brinell, Vickers and Shore.

This compact hardness tester is loaded with useful functions usually found only on high priced models.

### Features

- Leeb style tester designed for large, hard parts – load the impact body and place the impact device on your test piece
- Easy to use keypad operation – push the button to begin testing and obtain reading
- Auto identification of impact device
- Large LCD display with back light
- USB output
- Automatic conversions to Rockwell, Brinell, Vickers and Shore
- Automatic mean value as well as Min & Max values
- Uses two AA alkaline batteries with low power indicator
- Memory capacity (100 groups)
- Optional impact devices and special support rings

### Specifications

- Accuracy: +/- 0.5% (referred to L=800)
- Repeatability accuracy: +/- 4L units (L=Leeb)
- Measuring range: 200-960 HL
- For steel & cast steel, alloy tool steel, stainless steel, grey cast iron, spheroidal iron, cast aluminum, brass, bronze, wrought copper alloy
- Tool steel should be about 25mm (1") thick solid material or larger
- Operating temperature: -15-40° / 5-104°F
- Dimensions: 150 x 74 x 32mm (5.96 x 2.938 x 1.270")
- Weight: 245g (8.6 oz.)

### 3811A Hardness Tester & Accessories

Cat. No.	EDP	Description
3811A	69881	Digital portable hardness tester with impact device D, calibrated test block, cleaning brush and carry case
HT-1800-110*	20940	D+15 Impact Device
HT-1800-115*	20941	DL Impact Device
HT-1800-125*	20942	G Impact Device
HT-1800-130*	20943	C Impact Device
HT-1800-120*	20944	DC Impact Device
HT-1800-100*	20945	Replacement D Impact Device
HT-1800-102*	20946	Replacement Cable For All Impact Devices
HT-2500-105*	20947	Replacement Impact Body
HT-1300-01*	20948	Leeb D Test Block
HT-1100G-01*	20949	Leeb G Test Block

\* Not Stocked



## 3805A Electronic Durometer

The 3805A is a lightweight, ergonomically designed, reasonably priced durometer engineered to perform at the highest level of accuracy.

Capable of measuring hardness in Shore A values, the most popular scale, the portable durometer is ideal for fast, convenient testing of rubber, PVC, leathers, vinyl, acrylic and other similar materials. Contact is made with a 35° blunt point, ensuring superior accuracy.

### Features

- Accurate and repetitive deviation of 20-90 HA <math>\pm 1</math> grade
- Resolution of .1HA
- Measuring range of 0-100HA
- Conforms to ASTM D-2240, ISO 7619 standards
- Large, easy-to-read LCD display
- Automatic Off
- Ability to allow averaging and to lock in peak value
- Weighs only 233 grams (8.2 ounces)
- Compact size of 163 x 65 x 28mm (6.40 x 2.56 x 1.12")
- 4 AAA batteries, supplied with the tester
- Supplied with rubber test block RBR-63



Inspecting rubber plumbing hose

3805A Digital Durometer		
Description	Cat. No.	EDP
Durometer, in Fitted Case	3805A	12265
Accessories for 3805A Digital Durometer		
Rubber Test Block, Shore A 27-30, Red	RBR-30*	68197
Rubber Test Block, Shore A 61-63, Clear	RBC-63*	68198
Rubber Test Block, Shore A 90-94, Black	RBB-94*	68199
Set of 3 Blocks (1 ea: RBR-30, RBC-63, RBB-94)	SRB-3*	68200

\* Not Stocked

## 3812 Ultrasonic Thickness Tester

### State-of-the-Art Ultrasonic Gauge

The Starrett 3812 Ultrasonic Thickness Tester is a state-of-the-art digital ultrasonic thickness gauge packed with features typically found only on high end models.

It measures the thickness of metallic and non-metallic materials such as steel, aluminum, titanium, plastics, ceramics, glass and any other good ultrasonic wave conductor that has parallel top and bottom surfaces.

This dynamic ultrasonic thickness gauge accurately displays readings in either inch or millimetre units after a simple calibration to a known thickness or sound velocity.

### Features & Specifications

- 4 digit LCD display with back light
- Upper/Lower limit preset alarm
- Measurement and scanning capabilities
- Adjustable sound velocity
- Extended memory
- 20 memory groups (100 files/group)
- Minimum display unit: 0.01mm (0.001") selectable
- 0.75-300mm (0.030-12.0") measuring range (in steel with standard probe)
- 1000-9999m/s (3280-32805ft/s) sound velocity range
- 0-50°C / 32-122°F operating temperature
- 5MHz Frequency
- 4Hz update range
- USB output
- Power supply: Two 3V AA alkaline batteries with approximately 100 hours of life (with the backlight off)
- Power consumption: Working current is less than 3V
- Accuracy:  $\pm (0.5\% \text{ thickness} + .001" / 0.5\% \text{ thickness} + 0.01\text{mm})$
- Dimensions: 150 x 74 x 33mm (5.90" x 2.91" x 1.30")
- Weight: 245g (8.6oz)
- Includes tester and cables, software, USB cable, couplant gel and a rugged, form fit carrying case



### 3812 Ultrasonic Thickness Tester & Accessories

Description	Cat. No.	EDP
3812 Ultrasonic Thickness Gauge, software, USB cable, couplant gel and carry case	3812	67668





## SR100 Surface Roughness Tester

### Easy-to-Use & Accurate

With the SR100, you can measure roughness almost anywhere. It is ideal for checking large components, structures, auditing batch production prior to shipment and production line process control.

### Separates into Two Pieces

The bottom half of the SR100 contains the traverse mechanism and stylus pickup assembly which is placed on the surface to be measured. Its wide base ensures stability.

The upper half includes a large LCD display, start button, mode and parameter buttons, comfortably hand-held for easy operation and clear viewing.

### How it Works

A diamond stylus is drawn across the part. The motorized traverse mechanism is cam driven to ensure that the correct horizontal distance is traveled.

Vertical movement of the stylus as it travels across peaks and valleys is detected by a piezo-electric pickup which converts the mechanical movement of the stylus into an electric signal.

The electrical signal is digitized and sent to a microprocessor where the parameters are calculated using standardized algorithms.

### Features

- Large LCD window
- Measures Ra at the touch of a button
- In addition to basic roughness parameters Ra and Rz, also measures advanced Rp, Rv and Rt parameters
- Five second cycle time
- Result saved until the next measurement is taken
- Switches between inch and metric mode without remeasuring
- Use right out of the box – little or no operator training required
- Automatic shut-off after five minutes of inactivity
- Configured with the most common industrial settings to ensure correlation between multiple operators (see specifications)
- Simple and reliable calibration routine
- Uses standard off-the-shelf calculator type batteries with a minimum life of 5,000 measurements
- Includes SR100 two-piece assembly, calibration standard, batteries, operation guide and a carrying case



SR100 uses an infra-red (IrDA) link between the upper and lower units to provide remote, cable free operation up to a distance of one metre (40").

### Technical Specifications

Gauge range	200µm / 0.008"
Accuracy	5% of reading + 0.1µm / + 4µin
Pick up type	Piezoelectric
Gauge force	200mg / .007 oz.
Stylus	Diamond, Radius 5µm / 200µin
Cut off value	0.8mm / 0.03" ±15%
Filter	2CR
Traverse length	5mm / 0.2"
Traverse speed	2mm/sec, 0.08"/sec
Display units	µm / µin
Battery life	5,000 operations minimum

### Parameter results

Parameters	Range	Resolution
Ra:	40µm / 1600µin	0.01µm / 0.4µin
Rz, Rv, Rp, Rt:	199µm / 7800µin	0.1µm / 4µin

### Dimensions

Overall dimensions	125 x 80 x 38mm / 4.92 x 3.15x 1.5"
Weight	200gm / 7oz

### Component dimensions and condition

Min bore	65mm / 2.6"
Min diameter	25mm / 1.0"
Max temperature	35°C / 95°F

### Nominal operating conditions

Temperature	20°C / 68°F
Humidity	0 to 80% non condensing

### Storage conditions

Temperature	0 to 50°C / 32°F to 122°F
Humidity	0 to 80% non condensing

### SR100 Surface Roughness Tester & Accessories

Cat. No.	EDP	Description
SR100	20950	SR100 two-piece surface roughness tester assembly, calibration standard, batteries, operation guide and a carrying case

# SR200 Surface Roughness Tester

## Powerful, Flexible & Accurate

The SR200 is a full featured, powerful and versatile surface roughness tester. It can be used either freestanding (on horizontal, vertical or even inverted surfaces) or bench mounted with fixturing for batch measurement and laboratory applications. It is battery powered for portability, with an AC adapter available.

## Fast & Flexible

The SR200 can calculate as many as ten parameters (below) covering a comprehensive range of requirements. Its electronics provide very fast analysis – results are calculated and displayed even before the traverse unit returns. This fast processing, combined with intuitive menu buttons ensures measurement cycle productivity.

## Large Display & Intuitive Operation

The SR200 has a large LCD to display a full menu and all measurement results – scroll through the menus with the two control buttons, make your selections, then press the MEASURE key. All selections are saved for future measurements with a built-in memory capacity that holds up to 100 readings. The SR200 includes an RS232 port so all measurement criteria and results can be exported.

## Overview

- Large screen display
- Unique stylus lift mechanism for total flexibility
- Many application specific parameter options
- Comprehensive selection optional accessories and pickups
- Long traverse length and extended pickup reach
- TalyProfile Lite Windows software included with available Silver and Gold upgrade options
- Stores up to 100 readings

Technical Specifications	
<b>Pickup</b>	
Gauge range	300µm/0.012µ"
Resolution	0.01µm/0.04µ
Accuracy	2% of reading + LSD µm
Pickup type	Inductive
Gauge force	150-300mg/.005-.01oz.
Diamond stylus	Tip radius 5µm/200µ" unless otherwise specified
<b>Instrument</b>	
Cut off value	0.25, 0.8, 2.5, 8mm / 0.01, 0.03, 0.3"
Filter	2CR or gaussian (selectable)
Traverse length	0.25-25mm / 0.01-0.98"
Traverse speed	1mm/sec, 0.04"/sec
Display units	µm / µin
Data output	RS232
Power	9V battery or (optional) power supply
<b>Parameters</b>	
Ra, Rz, Rt, Rp, Rmr, Rpc, Rsm, Rz1max, Rsk, Rda	
<b>Storage Capacity</b>	
100 measurement results	
<b>Dimensions</b>	
Overall dimensions	127 x 85 x 60mm / 5 x 3.35 x 2.4"
Weight	450gm / 1lb
<b>Nominal operating conditions</b>	
Temperature	5-40°C / 41-104°F
Humidity	0 to 80% non-condensing
<b>Storage conditions</b>	
Temperature	0 to 50°C / 32°F to 122°F
Humidity	0 to 80% non-condensing

SR200 Surface Roughness Tester & Accessories		
Cat. No.	EDP	Description
SR200	20951	SR200 display and traverse unit, TalyProfile Lite software, pickup and diamond stylus, calibration standard, manual and carrying case
SR-112-1510*	20961	200mm/7.875" Extension Rod with Lead
SR-112-1534*	20962	Reference Standard
SR-112-1517*	20963	Support Stand
SR-112-2693*	20964	Column and Stand
SR-112-1502*	20956	Standard Pickup with 5µm/200µ" Stylus
SR-112-1503*	20957	Standard Pickup with 10µm/400µ" Stylus
SR-112-1504*	20958	Small Bore Pickup
SR-112-1505*	20959	Right Angle Pickup
SR-112-1506*	20960	Recess Pickup
SR-112-3680*	20952	TalyProfile Gold - 2D Analysis Software w/cable
SR-112-3681*	20953	TalyProfile Silver - 2D Analysis Software w/cable
SR-K509-1578*	20954	TalyProfile 2.5m/8' Cable
SR-K509-1820*	20955	TalyProfile 1.5m/5' Cable
SR-112-3530*	20965	Power Adapter UK
SR-112-3532*	20967	Power Adapter 230 Volt EURO

\* Not Stocked

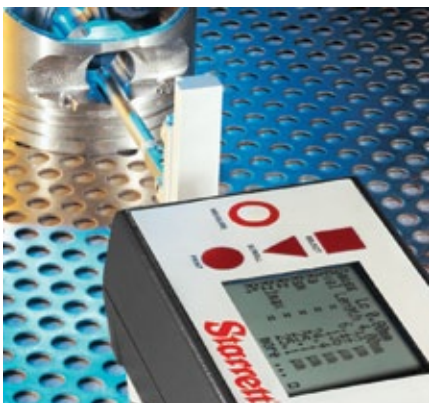
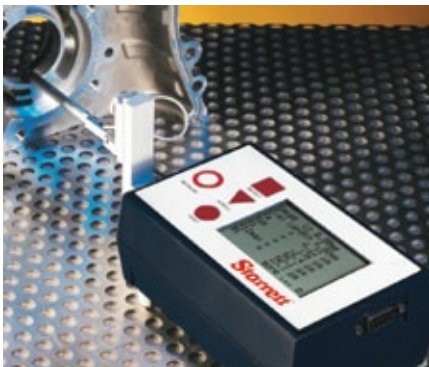
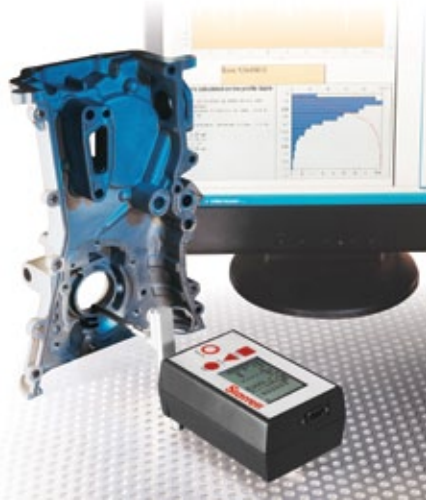

## Unique Stylus Lift Mechanism

The SR200 has a uniquely engineered stylus lift mechanism which allows a vertical adjustment of 50mm / 2" and rotation of the pickup to different measuring positions, including right angle or inverted measurements. These adjustments to the height and position of the gauge allow areas and features of a part to be easily measured without additional complex fixturing. This feature saves the operator a huge amount of set up time and allows total flexibility. Typical applications where the stylus lift is invaluable include the measurement of steps, bores, grooves and lands.

## Built-in Memory/Storage

The SR200 is truly portable with no PC or printer cables in the way of measurements – take it to wherever you need to take measurements, save up to 100 batch readings and then download to your PC or printer at your convenience.

## Long Traverse Length and Extended Pickup Reach

The SR200 can traverse up to 25mm / 1" (or as little as 0.25mm / 0.010") depending on your component. In addition, the stylus length and pick-up configuration give a long reach, making it an ideal instrument for features such as large and narrow bores.

## Comprehensive Range of Accessories & Pickups

An extensive range of pickups and accessories are available to suit the varied measurement needs of our customers.

## Pickups

A range of pick-ups are available to meet a variety of measurement requirements.

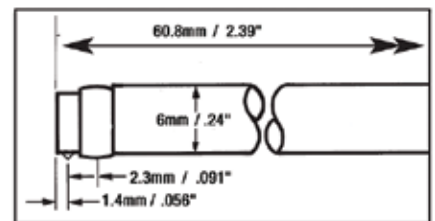

### Standard Pickup

For general surface roughness measurement.  
Cat. No. SR-112-1502; EDP 20956

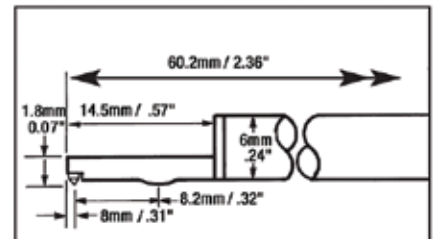

### Small Bore Pickup

For general use in small bores, grooves and on narrow surfaces.  
Cat. No. SR-112-1504; EDP 20958

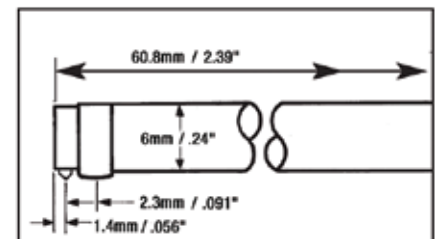

### Right Angle Pickup

For measurement at right angles to the direction of traverse.  
Cat. No. SR-112-1505; EDP 20959

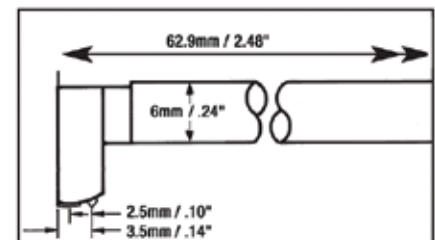

### Recess Pickup

For recesses to a depth of 5.7mm / 0.23"  
Cat. No. SR-112-1506; EDP 20960

## TalyProfile Lite Software

The SR200 includes TalyProfile Lite, Windows software with powerful analysis features.

After receiving data from the SR200, TalyProfile Lite can immediately analyze, print, export as a .txt or .csv file, or save it as a document that can be reopened and used as a template for future measurements.

### Outstanding Graphics

TalyProfile Lite provides clear on screen profile images. Users can take basic measurements and create a full report using the software's detailed analysis options and publishing capabilities.

### In-Depth Analysis

Profiles can be levelled and zoomed to remove unwanted features or defects from the analysis. Distance measurement between features and areas of a profile, step height, area of a hole and peak can all be easily displayed, graphically and numerically.

### Time-saving Templates

A sequence of analysis functions can be saved as a "template" and applied to future measurements, turning detailed reporting tasks into routine documents.

### Presentation

TalyProfile Lite includes professional presentation capabilities. Graphs, profiles and results can be arranged and printed within TalyProfile and also has the flexibility for export to other presentation software.

### Easy Upgrade Path

TalyProfile Lite provides an easy upgrade path to the more advanced Silver and Gold versions. TalyProfile Silver has all functions typically used for shopfloor inspection. TalyProfile Gold includes complete laboratory analysis functions.

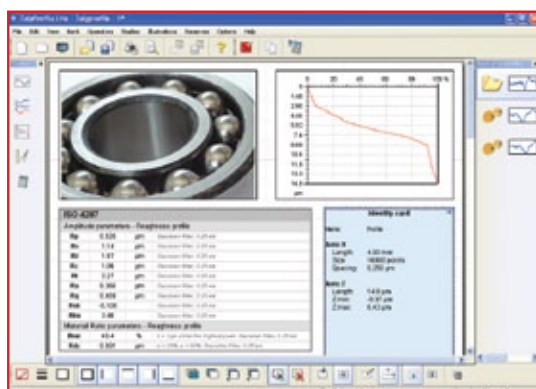
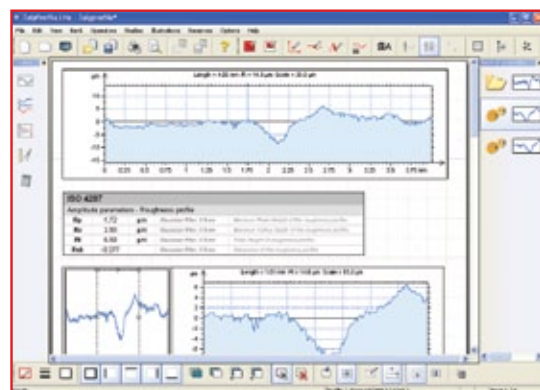
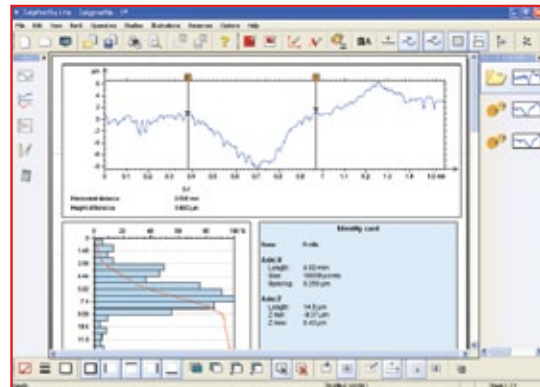

TalyProfile Features	Lite	Silver	Gold
Acquisition interface	X	X	X
Multiple file format reports	X	X	X
Graphical display	X	X	X
Desktop publishing templates	X	X	X
Document page viewer	X	X	X
Levelling	X	X	X
Symmetries	X	X	X
Zoom	X	X	X
Distance measurement	X	X	X
Profile curves	X	X	X
Area of a hole / peak	X	X	X
Abbott-Firestone Curve	X	X	X
Mini Documents		X	X
Save Profile (export data)		X	X
Basic & 2D file formats		X	X
Tolerance limits		X	X
Join Two Profiles			X
Resampling			X
Form removal			X
Retouch profile points			X
Filtering by FFT			X
Fractal analysis			X
R & W Motifs (ISO 12085)			X
Rk Calculation of Profiles			X
Graphical RK Parameters			X
Step height measurement			X
Frequency spectrum			X
Morphological Envelopes			X
Thresholding			X
Power spectrum density			X

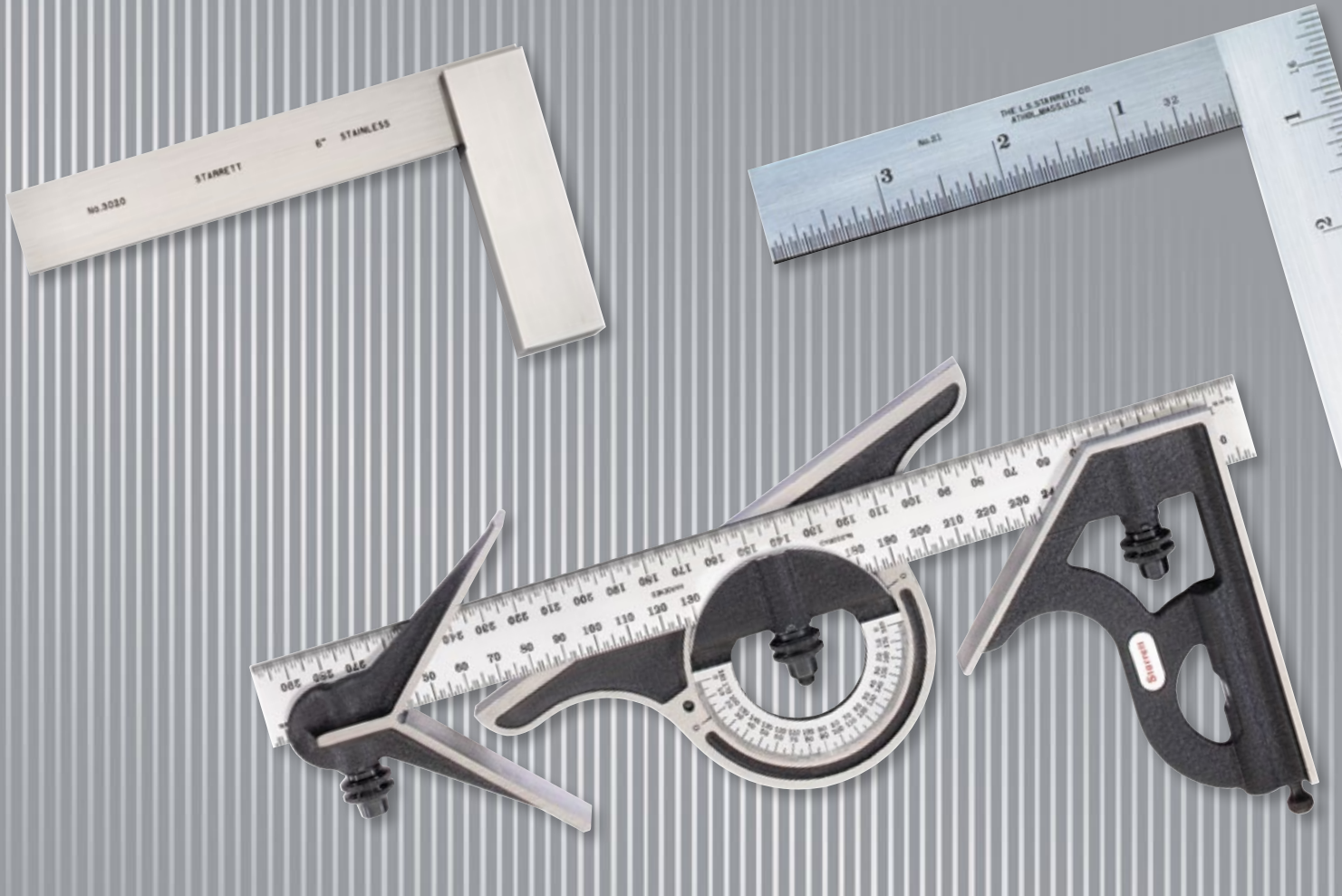

## Squares, Precision Rules & Parallels





## Combination Sets with Square, Centre and Reversible Protractor Head and Blade

435

### Cast Iron Heads:

With reversible lock bolts, scribe, spirit level in both square head and protractor head, direct reading double 180° protractor scale, hardened steel, photo-engraved blade. Cast iron heads with black wrinkle finish. Also available with satin chrome blade and protractor head.



### Combination Sets with Square, Centre and Reversible Protractor Head and Blade

Size	Graduation	Blade	Cast Iron Heads with Black Wrinkle Finish	
			Cat. No.	EDP
300mm	mm and 1/2mm Both Sides	Regular	435M-300	66177
600mm			435M-600	66681
300mm & 11-3/40	435ME-300		51560	
600mm & 23-1/2"	435ME-600		51561	



## 434 Forged and Hardened Steel Square and Centre Heads, Cast Iron Protractor Head:

These superb quality squares have the same features as the 435 except that the square heads and centre heads are forged, hardened steel with smooth, black enamel finish.



**Combination Sets with Square, Centre and Reversible Protractor Head and Blade**

Size	Graduation	Blade	Forged and Hardened Square and Centre Heads, Cast Iron Protractor Head with Smooth Black Finish	
			Cat. No.	EDP
300mm	mm and 1/2mm Both Sides	Regular	434M-300	56255
600mm			434M-600	56256



# Combination Sets with Square, Centre and Non-Reversible Protractor Head and Blade

Cast Iron Heads:

9

With reversible lock bolts, scriber, spirit level in both square head and protractor head, direct reading double 180° protractor scale, and hardened steel, photo-engraved blade. Cast iron heads with black wrinkle finish. Also available with satin chrome blade and protractor head.



### Combination Sets with Square, Centre and Non-reversible Protractor Head and Blade

Size	Graduation	Blade	Cast Iron Heads with Black Wrinkle Finish	
			Cat. No.	EDP
300mm	mm and 1/2mm Both Sides	Regular	9M-300	56253
600mm			9M-600	56254
300mm & 11-3/4"	1/2mm and 32nds One Side; mm and 64ths Reverse Side	Regular	9ME-300	50047
600mm & 23-1/2"			9ME-600	50048





## Combination Squares with Square Head

### Cast Iron Heads:

#### 11H

With reversible lock bolt, scribe, spirit level and hardened steel, photo-engraved blade with regular or satin chrome finish. Cast iron head with black wrinkle finish.

### Forged and Hardened Steel Heads:

#### 33H

These squares have the same features as the 11 except that the square heads are forged hardened steel with smooth, black enamel finish.

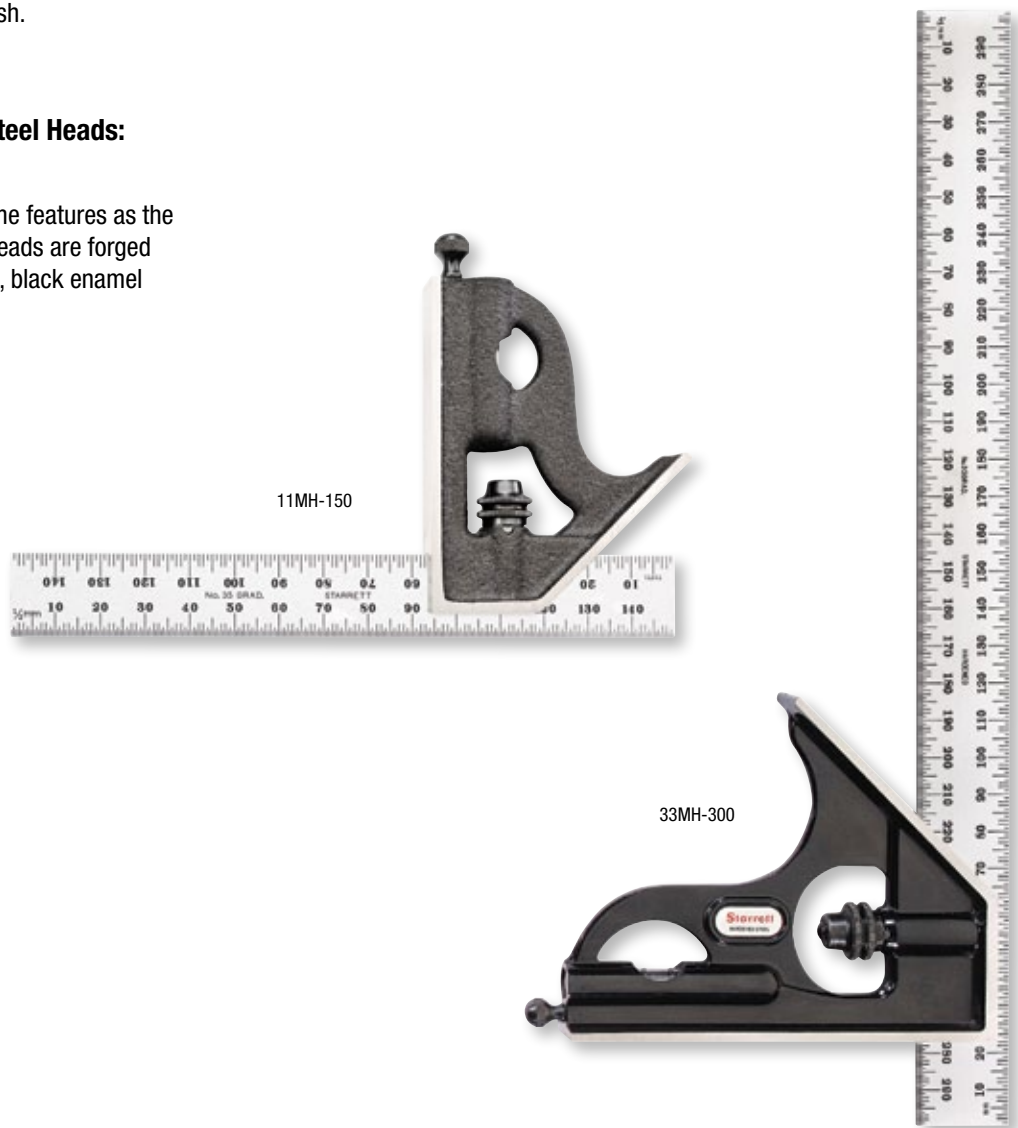

150-600mm Combination Squares with Square Head			11MH		33MH	
Size	Graduation	Blade	Cast Iron Heads with Black Wrinkle Finish		Forged and Hardened Steel Heads with Smooth Black Enamel Finish	
			Cat. No.	EDP	Cat. No.	EDP
300mm	mm and 1/2mm Both Sides	Regular	11MH-300	56243	33MH-300	56249
600mm		Regular	11MH-600	56245	33MH-600	56251



## 13 Double Squares with hardened blades

100-150mm

These squares are very popular with machinists, toolmakers, and patternmakers. The sliding blades are adjustable making it practical for a wide variety of uses. The faces of the head are ground square, and the 150mm size has a level.

The bevel blade is available, featuring an octagon angle 45° at one end and a hexagon angle 60° at the other end, clearly marked.

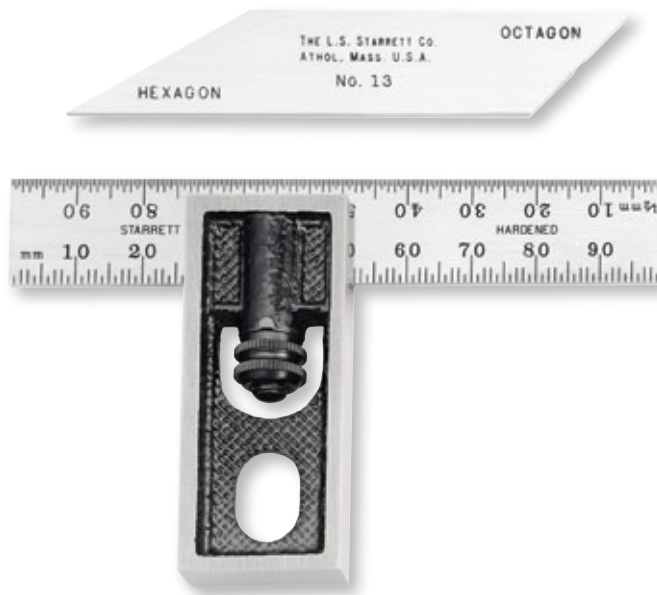

**Millimetre Reading Double Squares – mm Both Edges One Side; mm and 1/2mm Reverse Side**

Size	Description	Cat. No.	EDP
100mm	With Graduated Blade Only	13MA	56278
	With Graduated and Bevel Blades	13MB	56279
150mm	With Graduated Blade Only	13MC	56280
	With Graduated and Bevel Blades	13ME	56263

## 14 Double Steel Squares with hardened and ground head and blades

50mm

Designed for tool and diemakers, these fine precision double steel squares have adjustable blades, ideal for tight fits. A knurled clamping nut accurately locks the blades in any position.

Beveled blade is 45° on one end and 30° on the other.

58mm narrow blade has 32nds and 64ths graduations. It is 4mm wide over a length of approximately 41mm and cut away at one end to a width of 2.4mm.



**14 Double Steel Squares – mm Both Edges One Side; mm and 1/2mm Reverse Side**

Size	Graduation	Description	Cat. No.	EDP
50mm	mm, 1/2mm	With Graduated Blade Only	14MA	56260
		Complete with Graduated Narrow Blade and Bevel Blade	14MD	56261



## 3020 Toolmakers' Grade Stainless Steel Squares

50-175mm / 2-31/32 - 12-1/32"

- This high quality toolmakers' square is not graduated
- Squareness accuracy to 0.005mm (.0002") for every 150mm (6")
- Hardened, ground and lapped stainless steel construction on both the blade and the beam
- Beam is machined at the inner corner for clearance of burrs or dirt
- Packed one in a plastic case
- 300mm (12") square shipped in box with fitted foam insert



3020 Toolmakers' Grade Stainless Steel Squares			
Size – Length of Blade*	Length of Beam	Cat. No.	EDP
75mm/3"	50mm/2"	3020M-75	12392
100mm/4"	75mm/3"	3020M-100	12393
150mm/6"	100mm/4"	3020M-150	12394
300mm/12"	175mm/7"	3020M-300	12395
Complete Set of all 4 Squares		S3020MZ	12396

\*Length of blade from the inner edge of the beam to the end of the blade.

## 60 Precision Steel Squares

50-200mm / 2-8"

- Hardened, ground and lapped stainless steel blade
- Accuracy: 0.005mm per 150mm

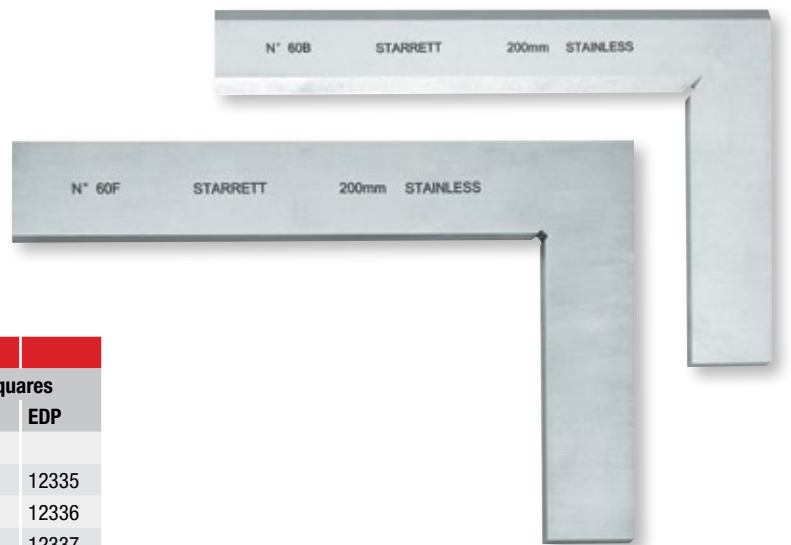

3020 Toolmakers' Grade Stainless Steel Squares				
Range	Beveled type squares		Plain type squares	
	Cat. No.	EDP	Cat. No.	EDP
50 x 40mm/2 x 1.6"	60B-50	12339		
75 x 50mm/3 x 2"	60B-75	12340	60F-75	12335
100 x 70mm/4 x 2.8"	60B-100	12341	60F-100	12336
150 x 100mm/6 x 4"	60B-150	12342	60F-150	12337
200 x 130mm/8" x 5.2"	60B-200	12343	60F-200	12338



## Millimetre Graduation Styles

30

- First Edge: None
- Second Edge: 1/2mm
- Fourth Edge: 1/2mm
- Third Edge: mm

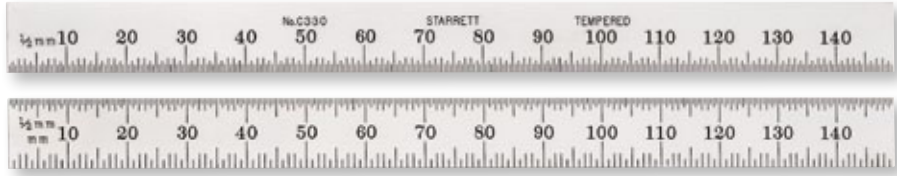

35

Reads both left-to-right and right-to-left. A Starrett original feature.

- First Edge: mm
- Second Edge: 1/2mm
- Fourth Edge: mm
- Third Edge: 1/2mm

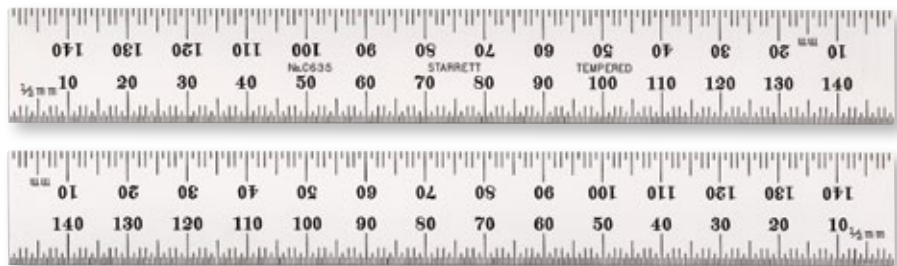

NOTE: All rules under 25mm in width have single row of millimetre figures. Rules 25mm and wider have double row of millimetre figures, and each edge represents the bottom edge reading left to right.

## Millimetre and Inch Graduation Styles

36\*

- First Edge: 32nds
- Second Edge: 1/2mm
- Fourth Edge: mm
- Third Edge: 64ths

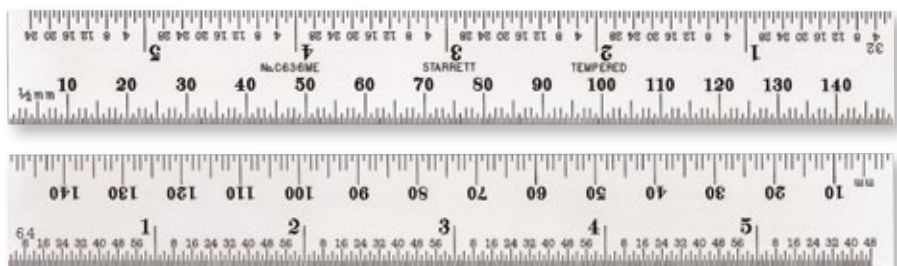

NOTE: \* Millimetre/Inch scale with emphasis on millimetre. Overall length is 150mm (5.905"). Inch graduations stop at 5-3/4" to avoid confusion.

### 36\* Style graduated as follows:

- 150mm end-to-end on mm edges and to 5-3/4" with a blank end on the inch edges
- 300mm end-to-end on mm edges and to 11-3/4" with a blank end on the inch edges
- 500mm end-to-end on mm edges and to 19-1/2" with a blank end on the inch edges
- 1000mm end-to-end on mm edges and to 39-1/4" with a blank end on the inch edges



## Steel Rules with Millimetre Graduations

150-1000mm

All rules furnished with Starrett satin chrome finish. Additional sizes and variations available on special order.

**Rules include:**

- Full-Flexible
- Spring-Tempered



Full-Flexible Steel Rules with Millimetre Graduations				
Length	Width x Thickness	Graduations	Cat. No.	EDP
150mm	12.7 x 0.4mm	30 – 1/2mm One Side; mm and 1/2mm on Reverse	*C330-150	51329
300mm	12.7 x 0.4mm	30 – 1/2mm One Side; mm and 1/2mm on Reverse	*C330-300	51330
Spring-Tempered Steel Rules with Millimetre Graduations				
150mm	19 x 1.2mm	35 – mm and 1/2mm Both Sides	C635-150	52630
300mm	25.4 x 1.2mm	35 – mm and 1/2mm Both Sides	C635-300	52631
500mm	29 x 1.2mm	35 – mm and 1/2mm Both Sides	C635-500	52632
1000mm	32 x 1.2mm	35 – mm and 1/2mm Both Sides	C635-1000	52633

\* Indicates rules with single row of millimetre figures (all rules under 25mm width). Rules without asterisk have double row of millimetre figures, and each edge represents the bottom edge reading left to right (rules 25mm and wider).

## Steel Rules with Millimetre and Inch Graduations

All rules are full millimetre lengths, except where noted. Additional sizes and variations available on special order.

**Rules include:**

- Spring-Tempered



Spring-Tempered Steel Rules with Millimetre and Inch Graduations				
Length	Width x Thickness	Graduations	Cat. No.	EDP
150mm & 5-3/4"	19 x 1.2mm	36 – 32nds and 1/2mm on One Side; 64ths and mm on Reverse	C636ME-150	52634
300mm & 11-3/4"	25.4 x 1.2mm	36 – 32nds and 1/2mm on One Side; 64ths and mm on Reverse	C636-300	52635
500mm & 19-1/2"	29 x 1.2mm	36 – 32nds and 1/2mm on One Side; 64ths and mm on Reverse	C636-500	52636
1000mm & 39-1/4"	32 x 1.2mm	36 – 32nds and 1/2mm on One Side; 64ths and mm on Reverse	C636-1000	52637



## 154 Adjustable Parallels

9.5-57mm (3/8 – 2-1/4")

Starrett adjustable parallels provide a wide range of uses in layout, gauging, inspection work and for setups on various machine tools. Their adjustable feature makes it possible to adjust them to exact size by micrometer measurement and also permits use in place of several solid-type parallels.

These parallels are useful as gauges in checking the size of slots and openings. They are also convenient for use in machine vises, for leveling or adjusting work on setups of milling and grinding machines, shapers, planers, drill presses and for many other applications.

Parallels slide smoothly and can be easily adjusted. The smaller sizes A, B, and C, are locked by one screw while the larger sizes, D, E, and F, have two lock screws. All parallels are 7mm thick.



Above: Set S154LZ with 154E in foreground  
Right: Checking inside measurement of slot with parallel and outside micrometer



## 384 Steel Parallels

3 x 25mm - 13 x 31mm  
(1/8" x 1" - 1/2" x 1-1/4")

Starrett 384 Steel Parallels are hardened and ground to close limits. They are indispensable for inspection and layout work or for various setups on drill presses, milling and grinding machines, shapers, etc. Furnished in pairs, 150mm / 6" length, they are made from a special grade of tool steel, hardened and accurately ground on the four sides. In tool rooms or machine shops, several pairs of these parallels will be of great value.



S384-3Z Parallel Set

### 154 Adjustable Parallel Sets

Length	Range	Cat. No.	EDP
45mm (1-3/4")	9.5-12.7mm (3/8 - 1/2")	154A	50578
55mm (2-1/8")	12.7-17.5mm (1/2 - 11/16")	154B	50579
70mm (2-11/16")	17.5-24mm (11/16 - 15/16")	154C	50580
90mm (3-9/16")	24-33mm (15/16 - 1-5/16")	154D	50581
105mm (4-3/16")	33-44mm (1-5/16 - 1-3/4")	154E	50582
130mm (5-1/16")	44-57mm (1-3/4 - 2-1/4")	154F	50583
Set of 4 Parallels in Case		S154SZ	50584
154A: 45mm (1-3/4")	9.5-12.7mm (3/8 - 1/2")	S154LZ	50586
154B: 55mm (2-1/8")	12.7-17.5mm (1/2 - 11/16")		
154C: 70mm (2-11/16")	17.5-24mm (11/16 - 15/16")		
154D: 90mm (3-9/16")	24-33mm (15/16 - 1-5/16")		
Set of 6 Parallels in Case			
154A: 45mm (1-3/4")	9.5-12.7mm (3/8 - 1/2")		
154B: 55mm (2-1/8")	12.7-17.5mm (1/2 - 11/16")		
154C: 70mm (2-11/16")	17.5-24mm (11/16 - 15/16")		
154D: 90mm (3-9/16")	24-33mm (15/16 - 1-5/16")		
154E: 105mm (4-3/16")	33-44mm (1-5/16 - 1-3/4")		
154F: 130mm (5-1/16")	44-57mm (1-3/4 - 2-1/4")		

### 384 Steel Parallel Sets, 150mm Length

Description	Cat. No.	EDP
Set of 4 Pairs in Case 384A: 3mm x 25mm (1/8" x 1") 384C: 5mm x 22mm (3/16" x 7/8") 384E: 6mm x 19mm (1/4" x 3/4") 384G: 10mm x 13mm (3/8" x 1/2")	S384JZ	51453
Set of 4 Pairs in Case 384N: 6mm x 13mm (1/4" x 1/2") 384M: 6mm x 10mm (1/4" x 3/8") 384P: 6mm x 16mm (1/4" x 5/8") 384F: 6mm x 25mm (1/4" x 1")	S384-1Z	63676
Set of 4 Pairs in Case 384G: 10mm x 13mm (3/8" x 1/2") 384H: 10mm x 19mm (3/8" x 3/4") 384R: 10mm x 25mm (3/8" x 1") 384M: 6mm x 10mm (1/4" x 3/8")	S384-2Z	63677
Set of 5 Pairs in Case 384S: 13mm x 16mm (1/2" x 5/8") 384T: 13mm x 19mm (1/2" x 3/4") 384W: 13mm x 25mm (1/2" x 1") 384X: 13mm x 28mm (1/2" x 1-1/8") 384Y: 13mm x 31mm (1/2" x 1-1/4")	S384-3Z	63678



## Fixed Gauges



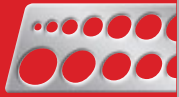

## 167 Radius or Fillet Gauges

### 0.5-15mm

Radii or fillets can be checked or laid out easier, faster, and more accurately with Starrett 167 Radius Gauges.

Many different sets for maximum convenience. Each set is furnished in an attractive case, providing complete protection and easy, instant selection of the right gauge size for the job.

#### Gauge Features

- Made of satin finish stainless steel – rust and stain resistant
- Each gauge is clearly marked with its radius
- Each gauge has five different gauging surfaces for both convex and concave radii
- All gauges have precision finished radii with extra smooth, accurate edges

#### Gauge Holder Features

- Any gauge can be used with the Starrett 110 holder which is especially useful for checking radii in confined or hard-to-reach locations
- Two slots are provided in the holder permitting gauges to be held at 30° or 45°, either square in the slot or tipped to one side
- The holder is 100mm (4") long, providing good reach and balance



Left: S167CHZ Radius Gauge Set with 25 gauges and holder in case  
Above: Gauging radii using gauge with holder

### Five Different Gauging Surfaces – Ideal for Checking Convex and Concave Radii of All Types

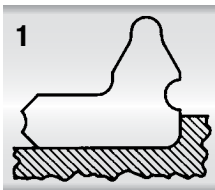

Fig 1. Checking concave (internal) radius with 90° arc. Also checks if sides are tangent to radius and 90° to each other.

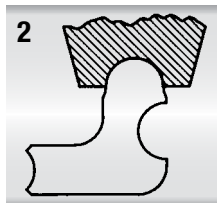

Fig 2. Checking concave (internal) radius with arc up to 180°. Also will check radius shown in Fig. 1 but not relationship of sides.

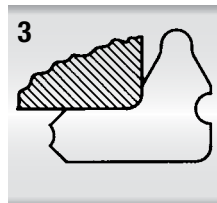

Fig 3. Checking convex (external) radius with 90° arc. Also checks if sides are tangent to radius and 90° to each other.

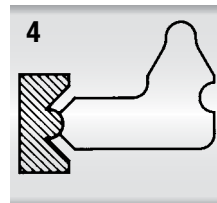

Fig 4. Checking convex (external) radius with arc of 90° or greater, or radii with sides as shown which would interfere with gauge used as in Fig. 3.

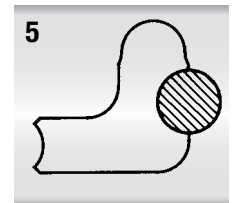

Fig 5. Checking convex (external) radius with arc of 180°; also less than 180° if sides of radius offer no interference.

#### S167M Radius Gauge Sets – Millimetre

Radii Range	Increments	Gauges	Description	Cat. No.	EDP
0.5-7mm; 8-15mm	0.5mm; 1mm	22	Sets 167MB and S167MAH Combined, With Holder	S167MCHZ	55821





## 269 Taper Gauges

2-25mm

- These gauges are for determining hole sizes in dies and all kinds of other work
- Read in 0.02mm, made of tempered steel with a locking device for fixing any leaf in position for use

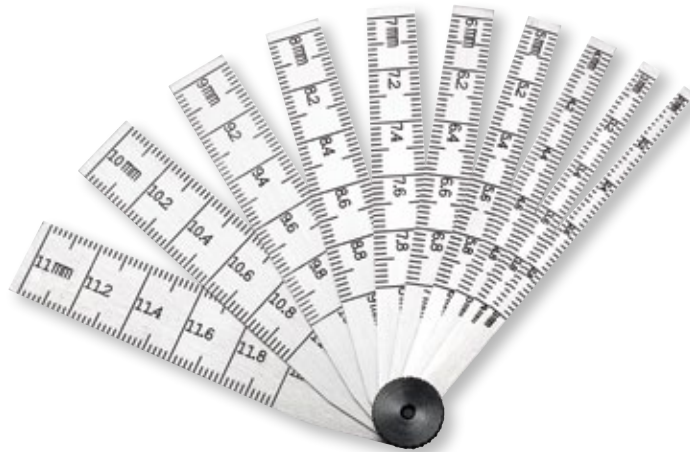

## 270 Taper Gauge

0.3-4mm / .010-.150"

- Very useful tool, especially for bearing work and for gauging slots
- Made of quality tool steel and accurately tapered throughout entire length for quick and convenient measuring
- 11mm / 7/16" wide by 160mm / 6-1/4" long
- Can be used as a precision shim
- One side graduated from 0.3mm to 4mm in one-twentieth of a mm (0.05mm); the reverse side from .010" to .150" in thousandths of an inch



## 272 Fillet or Radius Gauges

0.75-13mm

An external and internal radius on each leaf permits both concave and convex surfaces to be measured. The leaves are specially shaped for use in any position at any angle to measure fillets and radii in corners or against shoulders. Each leaf is stamped with the radius size and has an eccentric mounting for clearance between the leaf and the case when the gauge is opened.

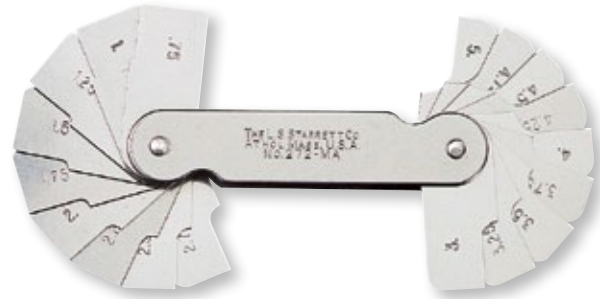
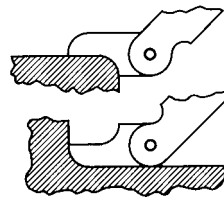

### 269 Taper Gauges - 0.02mm Graduation

Range	Length	Leaves	Cat. No.	EDP
2-12mm	64mm	10	269MA	56031
12-25mm	70mm	13	269MB	56032

### 270 Taper Gauge

Description	Cat. No.	EDP
Taper Gauge, 0.3-4mm range / .010-.150"	270	51292

### 272 Fillet or Radius Gauges

Range (Concave and Convex)	Increments	Leaves	Cat. No.	EDP
0.75-5mm	0.25mm	18	272MA	51297
5.5-13mm	0.5mm	16	272MB	51299

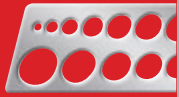

## Thickness Gauges

### 0.03-5mm

These gauges are used in automotive, aviation, diesel and farm equipment manufacture and service and also in jig, fixture, gauge and experimental work. Especially useful in adjusting tappets, spark plugs, distributor points, checking bearing clearances and gear play, fitting pistons, rings and pins and gauging narrow slots. Made in a wide range of types and sizes, each having from 6 up to 26 leaves ranging in thickness from 0.03-5mm, straight or tapered.

- Leaves made of finest tempered-steel, carefully finished to correct thickness, individually tested and marked with thickness
- Locking device permits securely locking one or more leaves in position
- Leaves easily removed or replaced
- Rugged, substantial steel case protects leaves



66MA



173MAT



173MCT

#### Millimetre Reading Thickness Gauges with Straight Leaves

Cat. No.	EDP	No. of Leaves	Size Leaves	(Range) Leaf Thickness (mm)
66MA	55974	20	12.7 x 77mm	0.05, 0.10, 0.15, 0.20, 0.25, 0.30, 0.35, 0.40, 0.45, 0.50, 0.55, 0.60, 0.65, 0.70, 0.75, 0.80, 0.85, 0.90, 0.95, 1.0
467M	52465		12.7 x 114mm	0.04, 0.05, 0.06, 0.07, 0.08, 0.10, 0.15, 0.20, 0.30, 1.0, 2.0, 3.0, 5.0

#### Millimetre Reading Thickness Gauges with Tapered Leaves

173MAT	57087	13	12.7-7 x 77mm	0.03, 0.04, 0.05, 0.06, 0.07, 0.08, 0.09, 0.10, 0.15, 0.20, 0.30, 0.40, 0.50
173MCT	57088		12.7-7 x 152mm	



## 156 & 159 International Metric Standard Screw Pitch Gauges

### 60° Threads

Starrett screw pitch gauges are among the most useful tools in any mechanics' tool box. They quickly determine the pitch of various threads. These gauges consist of a substantial steel case with a number of folding leaves at both ends, each leaf having teeth corresponding to a definite pitch, marked on each leaf.

Starrett screw pitch gauges are available in a wide range of sizes with different numbers of leaves in various pitch ranges with which to gauge.

### International Metric Standard 60° Threads

Starrett screw pitch gauges feature a locking device at both ends of the case, so leaves can be securely locked in position for use. Leaves on most gauges have a special narrow design, permitting checking internal threads in nuts, etc., as well as external threads.

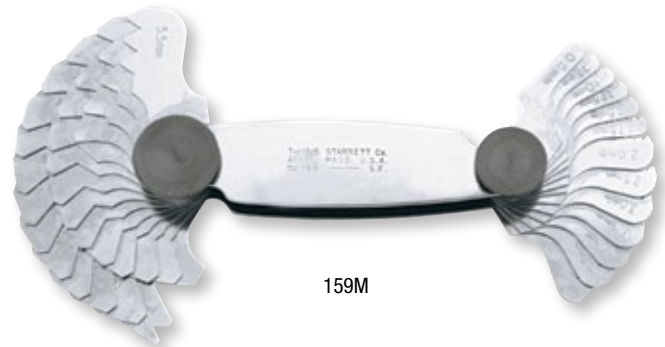

159M



156M

#### Screw Pitch Gauges

Cat. No.	EDP	No. of Leaves	TPI Range	Threads per 25.4mm/Inch (TPI)	Description
156M	50589	28	0.25-2.50mm	0.25, 0.30, 0.35, 0.40, 0.45, 0.50, 0.55, 0.60, 0.65, 0.70, 0.75, 0.80, 0.85, 0.90, 1, 1.10, 1.20, 1.25, 1.30, 1.40, 1.50, 1.60, 1.70, 1.75, 1.80, 1.90, 2, 2.50	With Locking Device
159M	50591	28	0.5-11.5mm	0.5, 0.75, 1, 1.10, 1.25, 1.5, 1.75, 2, 2.5, 3, 3.5, 4, 4.5, 5, 5.5, 6, 6.5, 7, 7.5, 8, 8.5, 9, 9.5, 10, 10.5, 11, 11.5	With Locking Device and 60° Centre Gauge



## 666 Thickness Gauge or “Feeler” Stock

**7.6m Dispenser Cases 0.03-0.35mm**

**6.1m Cardboard Boxes 0.40-0.50mm**

This handy product includes 667 thickness stock, housed in convenient rewindable dispenser rolls. Having the thickness stock in a case makes it very useful for cutting off the required length for adjusting tappets, spark plugs, distributor points, checking bearing clearances and gear play, fitting pistons, rings and pins, gauging narrow slots, etc. This stock is also useful for shimming in fixturing and die work.

- Handy 7.6m rolls, 12.7mm wide, in a compact, sturdy plastic rewindable dispenser case. This case handles stock up to 0.35mm only
- Rewind feature permits retracting thinner feeler stock into the case, preventing damage
- Roll stock in thicknesses of 0.40mm and over is furnished in 6m (nondispensable) rolls in a cardboard box.
- Made of the finest tempered steel
- Marked every 150mm with a line, thickness in hundredths of a mm
- Case provides the ability to snip off the desired length without any waste



## 667 Thickness Gauges or “Feeler” Stock

**0.03-0.50mm**

These gauges are widely used in automotive, aviation, diesel and farm equipment manufacture and service and also in jig, fixture, gauge and experimental work.

Furnished in 300mm lengths, 12.7mm wide in 14 different thicknesses ranging from 0.03-0.50mm

Rounded ends – no ragged edges make stock easier to work with

Made of the finest tempered steel

With convenient 5mm hole punched in the end for hanging



### 666M Thickness Gauge Rolls – Dispenser Case

Thickness	Length	Cat. No.	EDP
0.03mm	7.6m	666M-3	52823
0.04 mm		666M-4	52824
0.05mm		666M-5	52825
0.06mm		666M-6	52826
0.08mm		666M-8	52827
0.10mm		666M-10	52828
0.15mm		666M-15	52829
0.20mm		666M-20	52830
0.25mm		666M-25	52831
0.30mm		666M-30	52832
0.35mm		666M-35	52833

### 666M Thickness Gauge Rolls – Cardboard Box

Thickness	Length	Cat. No.	EDP
0.40mm	6.1m	666M-40	52834
0.45mm		666M-45	52835
0.50mm		666M-50	52836

### 667 Thickness Gauges – 300mm

Thickness	Cat. No.	EDP
0.03mm	667M-3	52869
0.04mm	667M-4	52870
0.05mm	667M-5	52871
0.06mm	667M-6	52872
0.08mm	667M-8	52873
0.10mm	667M-10	52874
0.15mm	667M-15	52875
0.20mm	667M-20	52876
0.25mm	667M-25	52877
0.30mm	667M-30	52878
0.35mm	667M-35	52879
0.40mm	667M-40	52880
0.45mm	667M-45	52881
0.50mm	667M-50	52882

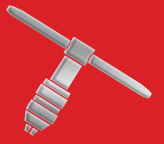

## Precision Shop Tools





## 98 Machinists' Levels with ground and graduated vials 100-450mm

These levels have ground and graduated main vials. All sizes have a cross test vial except the 100mm model.

The 300mm model also has a plumb vial and the 450mm size has a double plumb vial.

These vials are adjustable to a positive setting and are housed in a satin finished brass tube with a friction-fit closing cover to prevent breakage.

The base of the levels features an involute groove running the length of the base, which provides a reliable seat for round work such as pipes or shafting.

With the cross test vial, it is possible to simultaneously level in both directions. This prevents inaccuracies in the main vial reading caused by canting the level sidewise on round work.

The 150-450mm main level vials have graduations that are approximately 0.42mm per meter or 80-90 seconds. There are five, six, or seven lines on each side of the bubble, depending on the base length.



End view showing involute groove



### 98 Machinists' Levels with ground and graduated vials

Size mm	Description	Cat. No.	EDP
100mm	Without Cross Test Vial	98-4	50440
150mm	With Cross Test Vial	98-6	50441
200mm	With Cross Test Vial	98-8	50442
300mm	With Single Plumb Vial and Cross Test Vial	98-12	50443
450mm	With Double Plumb Vial and Cross Test Vial	98-18	50445

To guarantee extreme accuracy, the length of your level should not be longer than the work you are leveling.

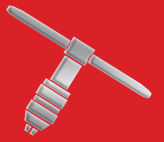

## 130 Bench Level

85mm

This is a very handy, compact bench level with a sensitive and accurate single vial. The body is made of seasoned cast iron with black wrinkle finish and an accurately machined base leveling surface.



### 130 Bench Level

Size	Description	Cat. No.	EDP
85mm	With Main Vial	130	50560

## 3097Z Precision Level

- Main vials have seven graduations on each side of the bubble with 10-second accuracy
- Auxiliary level vial shows lateral position and assists in horizontal setting
- One division on the vial represents 0.02mm/m
- Special alloy iron used to obtain freedom from thermal effects
- Includes attractive aluminum case



Cat No.	EDP	Size
3097Z	12312	200mm/8"



## 827 Edge Finders

### 10mm Body Diameters

#### For fast, accurate work location

Work surfaces may be located easily, quickly and accurately with these edge finders. Work with flat, straight edges, shoulders, grooves, round work, studs, dowels or centre points and scribed lines – all can be accurately located with this handy tool. Body and contacts are made of tool steel, hardened, ground and lapped to close tolerances for diameter and concentricity.

#### How To Use:

Edge finders are easy to use. They are placed in a collet or chuck. The worktable is then traversed to obtain contact between the rotating edge finder and the work. Contact will shift to concentric position relative to the body and with very slight additional table adjustment, will move off centre with a decided wobble. At this point, the centre of the finder is exactly one-half the diameter of the contact from the work edge, permitting accurate location for other machining operations relative to the edge.

For locating centre points and scribed lines, the pointed contact is used by putting a pencil or rule against the centre point and making it run concentrically. Then the point is brought down to the centre point or intersection of scribed lines and the table is adjusted so that when the tool barely touches the work, the lineup with the point in question can be ascertained.

827MA single end



Locating the centre with 827MB



827B with double end



Locating the edge of a part with 827MA

#### 827 Edge Finders

Description	Body Diameter	Contact Diameter	Cat. No.	EDP
Single End	10mm	6mm	827MA	56041
Double End	10mm	6mm and pointed contact	827MB	66452

Furnished in attractive, protective case.





## 73, 79, 83 "Yankee" Spring-Type Calipers and Dividers with flat legs and quick-spring nut

100, 150, 200, 300mm

Starrett "Yankee" Calipers and Dividers are made from a high-grade steel and well-finished. The legs are made of flat stock and are very durable. The fulcrum stud is hardened and has a smooth bearing surface. The bow spring, although flexible, is exceedingly strong to assure reliability.

The Starrett quick-adjusting automatic-closing spring nut is designed for making fast, positive adjustments. The threads of the nut firmly engage the screw at the slightest pressure from the leg. When the pressure is withdrawn, the nut automatically releases itself, sliding freely over the screw. This feature saves time in opening and closing.



## 274, 275 Toolmakers' Spring-Type Calipers with round legs and solid nut

75, 150mm

Starrett Toolmakers' Calipers are the finest tools of their type. Designed for toolmakers and all good mechanics who require finer adjustment and better balance so a more sensitive "feel" can be obtained. Precision made to rigid Starrett standards throughout.

The fulcrum stud is hardened and the bearing surfaces of the legs are large enough to prevent any side deflection. The bow spring is strong and flexible, and the adjustment is centrally located in the legs to assure smooth action.

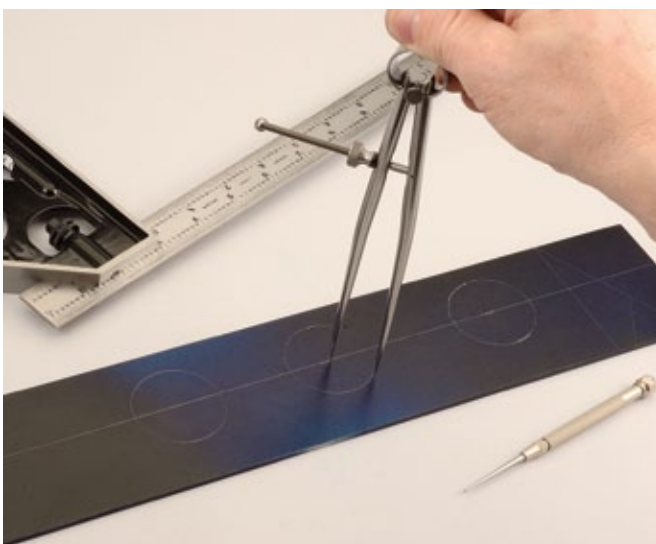

### 73 "Yankee" Spring-Type Inside Calipers

Size and Approx. Capacity	Cat. No.	EDP
100mm	73B-4	50335
150mm	73B-6	50337
200mm	73B-8	50339
300mm	73B-12	50343

### 79 "Yankee" Spring-Type Outside Calipers

100mm	79B-4	50365
150mm	79B-6	50367
200mm	79B-8	50369
300mm	79B-12	50373

### 83 "Yankee" Spring-Type Dividers

100mm	83B-4	50377
150mm	83B-6	50379
200mm	83B-8	50381
300mm	83B-12	50385

### 274 Toolmakers' Spring-Type Inside Calipers

75mm	274-3	51301
150mm	274-6	51303

### 275 Toolmakers' Spring-Type Outside Calipers

75mm	275-3	51305
150mm	275-6	51307



## Improved Firm-Joint Calipers

### 26 (Outside)

150-900mm

### 27 (Inside)

150-600mm

- Improved joint designed for tension adjustment
- Tension will not change with leg movement
- Legs are made from a high-grade steel, are ruggedly constructed and well-finished

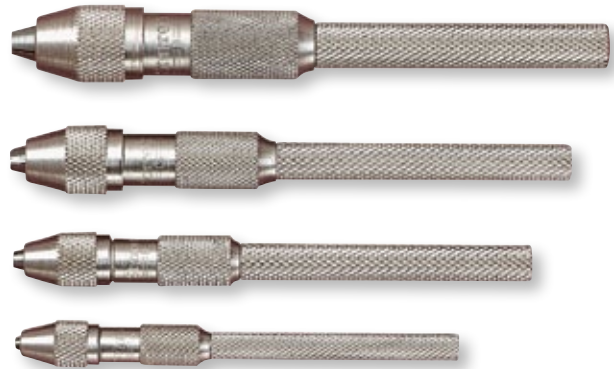

## 162 Pin Vises

0-4.8mm

Starrett pin vises are useful for securely holding small stock, taps, drills, reamers, scribers, wire, small files, and other tools. The jaws are hardened and with a few turns of the binding nut, a firm grip may be obtained. Handles and binding nuts are nickel-plated.

A hole extends through the full length of the handles so that wires of any length and any diameter up to the full size of the tool can be held.

The handles of these pin vises are reduced in size so that they can be rapidly rotated between thumb and finger when filing small work.

#### 26 Outside Calipers

Size*	Cat. No.	EDP
150mm	26-6	50186
300mm	26-12	50189
450mm	26-18	50190
600mm	26-24	50191
900mm	26-36	50192

#### 27 Inside Calipers

150mm	27-6	50193
300mm	27-12	50196
450mm	27-18	50197
600mm	27-24	50198

\* Actual capacity is one-third greater than the listed size.

#### 162 Pin Vises

Range	Cat. No.	EDP
0-1mm	162A	50599
0.8-1.6mm	162B	50600
1.3-3.2mm	162C	50601
2.9-4.8mm	162D	50602
Set of All 4 Sizes in Protective Vinyl Case	S162Z	50604

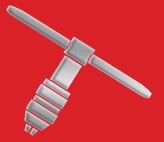

## 70 Pocket Scribers

### Carbide or Hardened Steel Points

The handle is of steel, knurled, and nickel plated. The scriber point is steel, properly hardened or carbide and finely tapered so that the location of the point is not obscured.

The scriber is held firmly in the handle by a knurled chuck and when not in use can be reversed, telescoped into the handle, and locked by the chuck. The hexagon-shaped head prevents rolling.

## 93 T-Handle Tap Wrenches

Starrett 93 T-Handle Tap Wrenches are for holding taps, drills, reamers and other small tools to be turned by hand. They are properly heat treated to withstand ordinary shop use.

The body is centered, enabling the worker to use it on lathe centres or on an upright drilling machine to start the tap straight. The jaws conform to the tool being held, making it rigid and less apt to loosen.

All wrenches have a sliding handle that is frictionally held. This feature permits the handle to be removed entirely or positioned so that leverage can be applied when working in close quarters.

The 93D, E and F sizes are identical in construction to the 93A, B and C models, except that the bodies are proportionately longer. These longer tap wrenches are very handy in machine, automobile service and aviation repair shops because they eliminate the need for stocking special long taps for depths which cannot be reached with shorter wrenches.

Note: These tools are designed to hold square shanks. Round shanks can be gripped, but care must be used. Excessive tightening may break the binding nut.

70 Pocket Scribers				
Point	Point Length	Handle Diameter	Cat. No.	EDP
Steel	60mm	6.4mm	70A	50323
	72mm	9.5mm	70B	50324
Carbide	60mm	6.4mm	70AX	50327
	72mm	9.5mm	70BX	56092

93 T-Handle Tap Wrenches				
Capacity		Body Length	Cat. No.	EDP
Tap Size	Square Shank			
1.6-4.7mm	1.6-4mm	50	93A	50427
5.5-11mm	4-6.4mm	65	93B	50428
6.4-12.7mm	4.7-8mm	90	93C	50429
1.6-4.7mm	1.6-4mm	150	93D	50430
5.5-11mm	4-6.4mm	250	93E	50431
6.4-12.7mm	4.7-8mm	330	93F	50432



## Automatic Centre Punches with Adjustable Stroke



Rugged automatic centre punch with adjustable stroke



Easy one-hand precision centre punching



Automatically locates and centres holes through hinges, latches, catches, etc.

### 18

Rugged automatic punches with all-steel handles and parts

- Internal mechanism automatically strikes a blow when downward pressure is applied
- Adjustable knurled cap regulates the force of the blow
- Spring tension, which regulates the blow, is constant so marks made by the point are uniform in depth and size for each setting
- All sizes are identical in style, differing only in the striking power
- The point can be easily removed for regrinding or replacement
- Heavy-duty 18C is capable of striking a much heavier blow than the other sizes

### 818

This punch is similar to our 18C, except that it has a lightweight, knurled aluminum handle for a positive grip and easy handling

- No hammer required! Just hold the punch in an upright position, press the handle down, and a built-in mechanism strikes a perfect centre mark every time
- The force of the blow can be adjusted by turning the knurled cap
- All working parts made of properly hardened tool steel. Hardened tool steel point may easily be removed for resharping or replacement.
- Works on metal, plastics, wood and other machinable materials

### 819 Hinge-Locating

This automatic centring punch combines all the features of our 818 lightweight aluminum punch with an exclusive self-centring locating sleeve that automatically centres starter holes for screws

- Simply engage the beveled edge of the sleeve with the countersunk hole in the hinge and press down on the handle until the built-in mechanism strikes a blow for truly concentric starting holes every time. To draw hinges, etc., sideways, tilt the punch slightly in the opposite direction.
- Eliminates the risk of drilling off centre, causing screws to pull hinges or hardware off centre
- Punch can be adjusted for striking light or heavy impressions by turning the knurled cap
- Point is easily removed for replacement or resharping

Automatic Centre Punches with Adjustable Stroke				
Description	Length	Diameter	Cat. No.	EDP
Punch	100mm	11mm	18AA	50119
	125mm	14mm	18A	50120
Punch, Heavy-Duty	130mm	17mm	18C	56757

818 Automatic Centre Punch			
Length	Diameter	Cat. No.	EDP
125mm	16mm	818	53048
819 Hinge-Locating Automatic Centre Punch			
125mm	16mm	819	53049

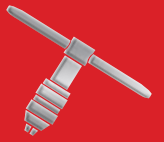

## 248 Drive Pin Punches for machine shop and motor service work

- Extra-long drive pin punches, measuring 200mm. The bodies are 115mm and the drive pin sections are 90mm long
- Well-proportioned, hardened, properly tempered with a knurled grip
- Designed to withstand hard use
- Provide a most satisfactory punch for machine shop and motor service work
- Diameter of punches is slightly less than listed

## 117 Centre Punches with Round Shanks

Starrett 117 Centre Punches are made of specially selected steel, hardened and properly tempered. They are well proportioned, nicely finished and have a knurled finger grip.

The points are ground at the proper angle to give maximum service, and the tips are accurately centreed.

248 & B248 Drive Pin Punches			
Length	Diameter Punch	Cat. No.	EDP
200mm	3mm	248A	51181
	5mm	248B	51182
	6mm	248C	51183
	8mm	248D	51184
	9.5mm	248E	51185
Set of 5, A, B, C, D, E in Protective Vinyl Case		S248PC	51186

117 Punches with Round Shanks			
Length	Dia. at Top of Tapered Point	Cat. No.	EDP
75mm	1.5mm	117AA	50482
	2mm	117A	50483
100mm	2.5mm	117B	50484
	3mm	117C	50485
	4mm	117D	50486
125mm	6.5mm	117E	50487
Set of 5, 117AA, A, B, C, D in Plastic Case		S117PC	50488



### 565 Drive Pin Punches

Starrett 565 Drive Pin Punches are well proportioned, hardened, properly tempered, nicely finished, and have a knurled finger grip. Each punch has the size stamped on the head.

### B565 Brass Drive Pin Punches

Our regular punches, made of hardened, tempered steel withstand heavy duty work, but at times are too hard and can damage softer materials. The new brass punches are ideal for these applications as they are much softer than the steel version.

The obvious disadvantage of brass punches is the same as their advantage -they are much softer than hardened steel. Obviously, the brass is less able to stand up to years of hard use.

Ideally, it is good to have sets of both types and use the brass punches only when there is the possibility of damage to the work piece.

Available in eight individual sizes from 1.5mm to 8mm and as a full set of eight in an attractive pouch.



565 Drive Pin Punches			
Length	Diameter Punch	Cat. No.	EDP
100mm	1.5mm	565A	52578
	2.5mm	565B	52579
	3mm	565C	52580
	4mm	565D	52581
	5mm	565E	52582
	5.5mm	565F	52583
	6mm	565G	52584
	8mm	565H	52585
Set of 8, A, B, C, D, E, F, G, H in Round Red Plastic Box		S565WB	52586
Set of 8, A, B, C, D, E, F, G, H in Vinyl Case		S565PC	52587

B565 Brass Drive Pin Punches			
Length	Diameter Punch	Cat. No.	EDP
100mm	1.5mm	B565A	12465
	2.5mm	B565B	12466
	3mm	B565C	12467
	4mm	B565D	12468
	5mm	B565E	12469
	5.5mm	B565F	12470
	6mm	B565G	12471
	8mm	B565H	12472
Set of 8, A, B, C, D, E, F, G, H in Fabric Pouch		SB565Z	12473

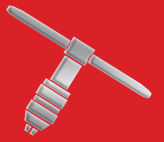

## 816 Prick Punches

When precise positioning of a point or an intersection of lines is required, these are the punches to use. The points are carefully ground to the correct taper, which is sharper than the normal centre punch.

This allows exact placement of the point, providing sharp impressions. These punches are properly hardened, tempered, and nicely finished.



## 800 Square-Head Nail Sets

- Round, knurled grip
- Large, square head provides a large striking surface and prevents the tool from rolling
- Beveled end prevents breakage
- Cupped punch surface to follow nail without sliding off
- Punch diameter clearly marked on the head
- Made of hardened and tempered steel

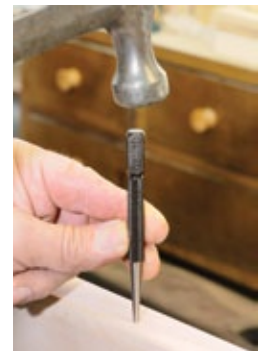

816 Prick Punches			
Length	Dia. at Top of Tapered Point	Cat. No.	EDP
100mm	2mm	816A	53043
	3mm	816B	53044
	4mm	816D	53046
Combination Starrett Punch Set in Plastic Case. One Each 816A, B, D Prick Punches, and Two Centre Punches 117AA, B.		S816PC	57078

800 Square-Head Nail Sets			
Length	Punch Diameter	Cat. No.	EDP
100mm	0.8mm	800A	53029
	1.5mm	800B	53030
	2.5mm	800C	53031
	3mm	800D	53032
	4mm	800E	53033
Set of 5 in Protective Plastic Case. One Each of 800A, B, C, D, E		S800PC	64131



## Rectangular Gauge Blocks



### One Millimetre Base

Rectangular Steel Gauge Block Sets in Case		B89.1.9 Accuracy Grade 0		
Measuring Range	Blocks Per Set	Blocks Included In Sets	Cat. No.	EDP
1.0 Through 61.0mm in 1.0mm Steps 2.0 Through 61.0mm in .5mm Steps 4.0 Through 61.0mm in .25mm Steps	9	3 blocks 1.0mm, 2.0mm, 2.25mm 4 blocks 2.5mm, 3.0mm, 5.0mm, 10.0mm 2 blocks 15.0mm, 25.0mm	RS 9.MA1*	93356
3.0 Through 450mm in .001mm Steps 2.0 Through 450mm in .01mm Steps 1.0 Through 450mm in .1mm Steps	45	9 blocks 1.001mm Through 1.009mm (Steps of .001mm) 9 blocks 1.01mm Through 1.09mm (Steps of .01mm) 9 blocks 1.1mm Through 1.9mm (Steps of .1mm) 9 blocks 1mm Through 9mm (Steps of 1mm) 9 blocks 10mm Through 90mm (Steps of 10mm)	RS 45.MA1*	93059
3.0 Through 450mm in .0005mm Steps 2.0 Through 450mm in .001mm Steps 1.0 Through 450mm in .01mm Steps 1.0 Through 450mm in .1mm Steps	88	1 block .5mm 1 block 1.0005mm 9 blocks 1.001mm Through 1.009mm (Steps of .001mm) 49 blocks 1.01mm Through 1.49mm (Steps of .01mm) 18 blocks 1mm Through 9.5mm (Steps of .5mm) 10 blocks 10mm Through 100mm (Steps of 10mm)	RS 88.MA1*	92872
3.0 Through 250mm in .0005mm Steps 2.0 Through 250mm in .001mm Steps 1.0 Through 250mm in .01mm Steps 1.0 Through 250mm in .1mm Steps	112	1 block .5mm 1 block 1.0005mm 9 blocks 1.001mm Through 1.009mm (Steps of .001mm) 49 blocks 1.01mm Through 1.49mm (Steps of .01mm) 48 blocks 1mm Through 24.5mm (Steps of .5mm) 4 blocks 25mm Through 100mm (Steps of 25mm)	RS 112.MA1*	93060
Micrometer Checking Set		B89.1.9 Accuracy Grade AS1		
	10	10 blocks 2.5mm, 5.1mm, 7.7mm, 10.3mm, 12.9mm 15.0 mm, 17.6mm, 20.2mm, 22.8mm, 25.0mm	RS 10.MA*	99753
Rectangular Ceramic Gauge Block Sets in Case				
3.0 Through 450mm in .001mm Steps 2.0 Through 450mm in .01mm Steps 1.0 Through 450mm in .1mm Steps	45	9 blocks 1.001mm Through 1.009mm (Steps of .001mm) 9 blocks 1.01mm Through 1.09mm (Steps of .01mm) 9 blocks 1.1mm Through 1.9mm (Steps of .1mm) 9 blocks 1mm Through 9mm (Steps of 1mm) 9 blocks 10mm Through 90mm (Steps of 10mm)	RY 45.MAA*	97634
3.0 Through 450mm in .0005mm Steps 2.0 Through 450mm in .001mm Steps 1.0 Through 450mm in .01mm Steps 1.0 Through 450mm in .1mm Steps	88	1 block .5mm 1 block 1.0005mm 9 blocks 1.001mm Through 1.009mm (Steps of .001mm) 49 blocks 1.01mm Through 1.49mm (Steps of .01mm) 18 blocks 1mm Through 9.5mm (Steps of .5mm) 10 blocks 10mm Through 100mm (Steps of 10mm)	RY 88.MAA*	97081

Sets include etched serial numbers and Commercial Calibration Certificate. Metric croblox® Wear Blocks and/or Master Calibration Certificate are available at extra cost.

\* Not Stocked

	Tolerances expressed in micrometers (0.001mm)					
	Webber Grade AA B89.1.9 Grade 00			Webber Grade A1 B89.1.9 Grade 0		
	Size Tolerance	Variation in Length Tolerance	Flatness Tolerance	Size Tolerance	Variation in Length Tolerance	Flatness Tolerance
Thru 0.5mm	+.10/-.10	.05	.05	+.14/-.14	.10	.10
Thru 10mm	+.07/-.07	.05	.05	+.12/-.12	.10	.10
Thru 25mm	+.07/-.07	.05	.05	+.14/-.14	.10	.10
Thru 50mm	+.10/-.10	.06	.05	+.20/-.20	.10	.10
Thru 75mm	+.12/-.12	.07	Rect (.05), Sq. (.07)	+.25/-.25	.12	.10
Thru 100mm	+.15/-.15	.07	Rect (.05), Sq. (.07)	+.30/-.30	.12	.10
Thru 125mm	+.20/-.20	.08	Rect (.05), Sq. (.07)	+.40/-.40	.14	.10
Thru 150mm	+.20/-.20	.08	Rect (.05), Sq. (.07)	+.40/-.40	.14	.10
Thru 175mm	+.25/-.25	.09	.10	+.50/-.50	.16	.15
Thru 200mm	+.25/-.25	.09	.10	+.50/-.50	.16	.15
Thru 250mm	+.30/-.30	.10	.10	+.60/-.60	.16	.15
Thru 300mm	+.35/-.35	.10	.10	+.70/-.70	.18	.15
Thru 400mm	+.45/-.45	.12	.10	+.90/-.90	.20	.15
Thru 500mm	+.50/-.50	.14	.10	+1.1/-1.1	.25	.15





## 3047.0, 3047.1, 3088.0, 3088.1 Precision Gauge Blocks

- Manufactured from a high grade of steel to ISO 3650 Grade "0" or Grade "1"
- Carefully heat treated and stress relieved for high stability
- Precision lapped for good wringing properties
- Each block is stamped with individual size
- Supplied with a UKAS Calibration Certificate



## 682EMZ Saw Tension Gauge

The Saw Tension Gauge will check for proper blade tension in either English or metric, and is graduated both in pounds and kilograms.

The tension gauge can be read directly on band saws of any type or power hacksaws.

It is graduated to read up to 60,000 PSI or 4,000kg per cm<sup>2</sup> and is furnished with instructions, including suggested tensions.

Cat No.	EDP	No. of Blocks	Description
3047-0	20804	47 Grade "0"	1.005, 1.01 to 1.19 by 0.01mm step, 1.2 to 1.9 by 0.1mm step, 1-10 by 1mm step, 20-100 by 10mm step
3047-1	20805	47 Grade "1"	1.0005, 1.001 to 1.009 by 0.001mm step, 1.01 to 1.49 by 0.01mm step, 0.5 to 9.5 by 0.5mm step, 10-100 by 10mm step
3088-0	20806	88 Grade "0"	1.0005, 1.001 to 1.009 by 0.001mm step, 1.01 to 1.49 by 0.01mm step, 0.5 to 9.5 by 0.5mm step, 10-100 by 10mm step
3088-1	20807	88 Grade "1"	1.0005, 1.001 to 1.009 by 0.001mm step, 1.01 to 1.49 by 0.01mm step, 0.5 to 9.5 by 0.5mm step, 10-100 by 10mm step

682EMZ Saw Tension Gauge	
Cat. No.	EDP
682EMZ	57075

<b>B</b>		<b>Machinists' Precision Shop Tools</b> . . . . .	75
<b>Bore Gauges</b> . . . . .	36	<b>Micrometers</b>	
<b>C</b>		Depth . . . . .	15
<b>Calibration, Accuracy/General Service Information</b> . . . . .	v	Electronic	
<b>Calipers</b>		Depth . . . . .	16
Leg Type . . . . .	79	Outside . . . . .	2
Slide Type . . . . .	19	Heads . . . . .	12
Dial . . . . .	24	Inside . . . . .	17
Electronic . . . . .	20	End Measuring Rods . . . . .	12
Vernier . . . . .	24	Heads & Solid Rods . . . . .	12
<b>Combination Squares</b> . . . . .	60	Internal Micrometers . . . . .	17
<b>D</b>		Tubular . . . . .	18
<b>Depth Gauges</b> . . . . .	26	Outside . . . . .	2
<b>Dividers</b> . . . . .	79	Blade-Type . . . . .	8
<b>Durometer</b> . . . . .	53	Can Seam . . . . .	9
<b>E</b>		Disc-Type . . . . .	7
<b>Edge Finders</b> . . . . .	78	Insulated Frame . . . . .	5
<b>G</b>		Interchangeable Anvil . . . . .	6
<b>Gauge Blocks</b> . . . . .	86	Mechanical . . . . .	4
<b>Gauges</b>		Mul-T-Anvil . . . . .	10
Crankshaft Distortion Dial/Strain . . . . .	46	Rounded Anvils . . . . .	9
Dial		Sheet Metal . . . . .	11
Groove . . . . .	45	Special Function . . . . .	7
Thickness . . . . .	44	V-Anvil . . . . .	8
Universal Back-Plunger . . . . .	41	Stand . . . . .	5
"Feeler" Stock/Thickness . . . . .	72	<b>P</b>	
Fillet . . . . .	70	<b>Parallels</b> . . . . .	68
Fixed Gauges . . . . .	69	<b>Pin Vises</b> . . . . .	80
Hole . . . . .	34	<b>Precision Shop Tools</b> . . . . .	75
Radius . . . . .	70	<b>Punches</b> . . . . .	82
Screw Pitch . . . . .	73	<b>R</b>	
Taper . . . . .	71	<b>Rules</b>	
Thickness . . . . .	72	Precision . . . . .	66
<b>H</b>		<b>S</b>	
<b>Height Gauges</b> . . . . .	27	<b>Saw Tension Gauge</b> . . . . .	87
<b>I</b>		<b>Scribers</b>	
<b>Indicators</b>		Pocket . . . . .	81
Bases . . . . .	42	<b>Squares</b>	
Dial . . . . .	40	Double . . . . .	64
Special Function . . . . .	44	Solid . . . . .	65
Spindle Squares . . . . .	48	Toolmakers' Stainless Steel . . . . .	65
Electronic . . . . .	38	<b>T</b>	
Holders . . . . .	42	<b>Tap Wrenches</b> . . . . .	81
<b>L</b>		<b>Testers</b>	
<b>Levels</b>		Hardness . . . . .	50
Precision . . . . .	76	Surface & Hardness . . . . .	49
<b>M</b>		Surface Roughness . . . . .	55
		Thickness . . . . .	54

<b>9</b>	Combination Squares . . . . .	62	<b>579</b>	Telescoping Gauges . . . . .	35
<b>11H</b>	Combination Squares . . . . .	63	<b>C635</b>	Steel Rules . . . . .	67
<b>13</b>	Double Squares with hardened blades . . . . .	64	<b>649</b>	Spindle Square . . . . .	48
<b>14</b>	Double Steel Squares . . . . .	64	<b>653</b>	Dial Gauge Stands . . . . .	42
<b>18</b>	Automatic Centre Punches . . . . .	82	<b>660</b>	Magnetic Base Indicator Holder . . . . .	42
<b>26</b>	Firm-Joint Calipers, Outside . . . . .	80	<b>661</b>	Mini Magnetic Indicator Holder . . . . .	43
<b>27</b>	Firm-Joint Calipers, Inside . . . . .	80	<b>666</b>	Thickness Gauges/"Feeler" Stock . . . . .	74
<b>33H</b>	Combination Squares . . . . .	63	<b>667</b>	Thickness Gauges/"Feeler" Stock . . . . .	74
<b>60</b>	Precision Steel Squares . . . . .	65	<b>682EMZ</b>	Saw Tension Gauge . . . . .	87
<b>63</b>	Long Range Micrometer Heads . . . . .	13	<b>696</b>	Crankshaft Distortion Dial/Strain Gauge . . . . .	46
<b>66</b>	Thickness Gauge . . . . .	72	<b>733</b>	Electronic Micrometers (w/ output) . . . . .	3
<b>70</b>	Pocket Scribes . . . . .	81	<b>749</b>	Electronic Micrometer Depth Gauge . . . . .	16
<b>73</b>	"Yankee" Inside Calipers . . . . .	79	<b>762</b>	Micrometer Heads . . . . .	14
<b>79</b>	"Yankee" Outside Calipers . . . . .	79	<b>795</b>	Electronic Micrometers (w/ output) . . . . .	2
<b>83</b>	"Yankee" Dividers . . . . .	79	<b>796</b>	Electronic Micrometers . . . . .	2
<b>93</b>	T-Handle Tap Wrenches . . . . .	81	<b>798</b>	Electronic Calipers . . . . .	20
<b>98</b>	Machinists' Levels . . . . .	76	<b>799</b>	Electronic Calipers . . . . .	22
<b>SR100</b>	Surface Roughness Tester . . . . .	55	<b>800</b>	Square-Head Nail Sets . . . . .	85
<b>117</b>	Centre Punches . . . . .	83	<b>816</b>	Prick Punches . . . . .	85
<b>124</b>	Inside Micrometers . . . . .	17	<b>818</b>	Automatic Centre Punches . . . . .	82
<b>125</b>	Vernier Calipers . . . . .	24	<b>819</b>	Automatic Centre Punches . . . . .	82
<b>130</b>	Bench Level . . . . .	77	<b>823</b>	Tubular Inside Micrometer Sets . . . . .	18
<b>154</b>	Adjustable Parallels . . . . .	68	<b>827</b>	Edge Finders . . . . .	78
<b>156</b>	Screw Pitch Gauge . . . . .	73	<b>829</b>	Small Hole Gauges . . . . .	34
<b>159</b>	Screw Pitch Gauge . . . . .	73	<b>831</b>	Small Hole Gauges . . . . .	34
<b>162</b>	Pin Vises . . . . .	80	<b>1015</b>	Portable Dial Thickness Gauges . . . . .	44
<b>167</b>	Radius/Fillet Gauges . . . . .	70	<b>1175</b>	Dial Indicator Groove Gauges . . . . .	45
<b>173</b>	Thickness Gauges . . . . .	72	<b>1202</b>	Dial Calipers . . . . .	24
<b>196</b>	Universal Back-Plunger Dial Indicators . . . . .	41	<b>2000</b>	Altissimo® Electronic Height Gauges . . . . .	30
<b>SR200</b>	Surface Roughness Tester . . . . .	56	<b>2900</b>	Electronic Indicators . . . . .	38
<b>207</b>	Can Seam Outside Micrometers . . . . .	9	<b>3015</b>	Portable Dial Thickness Gauge . . . . .	44
<b>208</b>	Can Seam Outside Micrometers . . . . .	9	<b>3020</b>	Toolmakers' Grade Stainless Steel Squares . . . . .	65
<b>220</b>	Mul-T-Anvil Micrometer . . . . .	10	<b>3025</b>	Dial Indicators . . . . .	40
<b>222</b>	Sheet Metal Micrometer . . . . .	11	<b>3047.0</b>	Precision Gauge Blocks . . . . .	87
<b>224</b>	Interchangeable Anvil Micrometers . . . . .	6	<b>3047.1</b>	Precision Gauge Blocks . . . . .	87
<b>234</b>	End Measuring Rods . . . . .	12	<b>3081</b>	Dial Indicators . . . . .	40
<b>248</b>	Drive Pin Punches . . . . .	83	<b>3088.0</b>	Precision Gauge Blocks . . . . .	87
<b>256</b>	Disc-Type Outside Micrometers . . . . .	7	<b>3088.1</b>	Precision Gauge Blocks . . . . .	87
<b>263</b>	Micrometer Heads . . . . .	12	<b>3089</b>	Dial Bore Gauge . . . . .	36
<b>269</b>	Taper Gauges . . . . .	71	<b>3097Z</b>	Precision Level . . . . .	77
<b>270</b>	Taper Gauge . . . . .	71	<b>3206</b>	Outside Micrometer Stand . . . . .	5
<b>272</b>	Fillet or Radius Gauges . . . . .	71	<b>3259</b>	Dial & Digital Height Gauges . . . . .	32
<b>274</b>	Toolmakers' Inside Calipers . . . . .	79	<b>3600</b>	Electronic Indicators . . . . .	39
<b>275</b>	Toolmakers' Outside Calipers . . . . .	79	<b>3657</b>	Magnetic Indicator Holders . . . . .	43
<b>C330</b>	Steel Rules . . . . .	67	<b>3732</b>	Electronic Micrometers . . . . .	3
<b>384</b>	Steel Parallels . . . . .	68	<b>3751</b>	Electronic Height Gauge . . . . .	27
<b>434</b>	Combination Squares . . . . .	61	<b>3752</b>	Electronic Height Gauges . . . . .	28
<b>435</b>	Combination Squares . . . . .	60	<b>3753</b>	Electronic Depth Gauges . . . . .	26
<b>436</b>	Outside Micrometers . . . . .	4	<b>3805A</b>	Electronic Durometer . . . . .	53
<b>440</b>	Depth Micrometers . . . . .	15	<b>3808</b>	Dial Indicators . . . . .	40
<b>444</b>	Micrometers with Insulated Frames . . . . .	5	<b>3809</b>	Dial Indicators . . . . .	40
<b>445</b>	Depth Micrometers . . . . .	15	<b>3811A</b>	Compact Hardness Tester . . . . .	52
<b>449</b>	Micrometer Depth Gauges . . . . .	15	<b>3812</b>	Ultrasonic Thickness Tester . . . . .	54
<b>460</b>	Micrometer Heads . . . . .	13	<b>3814</b>	Analog Bench Hardness Tester . . . . .	50
<b>463</b>	Micrometer Heads . . . . .	13	<b>3815</b>	Twin Analog Bench Hardness Tester . . . . .	51
<b>467</b>	Thickness Gauges . . . . .	72	<b>RS 9.MA1</b>	Rectangular Steel Gauge Block Set . . . . .	86
<b>483</b>	V-Anvil Outside Micrometers . . . . .	8	<b>RS 10.MA</b>	Micrometer Checking Set . . . . .	86
<b>486</b>	Blade Type Outside Micrometers . . . . .	8	<b>RS 45.MA1</b>	Rectangular Steel Gauge Block Set . . . . .	86
<b>565</b>	Drive Pin Punches . . . . .	84	<b>RS 88.MA1</b>	Rectangular Steel Gauge Block Set . . . . .	86
<b>B565</b>	Brass Drive Pin Punches . . . . .	84	<b>RS 112.MA1</b>	Rectangular Steel Gauge Block Set . . . . .	86
<b>576</b>	Rounded Anvil Outside Micrometers . . . . .	9	<b>RY 45.MAA</b>	Rectangular Ceramic Gauge Block Set . . . . .	86
<b>577</b>	Rounded Anvil Outside Micrometers . . . . .	9	<b>RY 88.MAA</b>	Rectangular Ceramic Gauge Block Set . . . . .	86

<b>Bore Gauges</b> . . . . .	<b>36</b>
<b>Calipers &amp; Dividers</b> . . . . .	<b>79</b>
<b>Depth Gauges</b> . . . . .	<b>26</b>
<b>Fixed Gauges</b> . . . . .	<b>69</b>
<b>Gauge Blocks</b> . . . . .	<b>86</b>
<b>Height Gauges</b> . . . . .	<b>25</b>
<b>Hole Gauges</b> . . . . .	<b>34</b>
<b>Indicators &amp; Gauges</b> . . . . .	<b>37</b>
<b>Indicators, Dial</b> . . . . .	<b>40</b>
<b>Indicators, Electronic</b> . . . . .	<b>38</b>
<b>Indicators, Holders</b> . . . . .	<b>42</b>
<b>Indicators, Special Function</b> . . . . .	<b>44</b>
<b>Levels, Precision</b> . . . . .	<b>76</b>
<b>Micrometers, Depth</b> . . . . .	<b>15</b>
<b>Micrometers, Electronic Outside</b> . . . . .	<b>2</b>
<b>Micrometers, End Measuring Rods</b> . . . . .	<b>12</b>
<b>Micrometers, Heads</b> . . . . .	<b>14</b>
<b>Micrometers, Inside</b> . . . . .	<b>17</b>
<b>Micrometers, Mechanical Outside</b> . . . . .	<b>4</b>
<b>Micrometers, Special Function Outside</b> . . . . .	<b>7</b>
<b>Parallels</b> . . . . .	<b>68</b>
<b>Precision Shop Tools</b> . . . . .	<b>75</b>
<b>Precision Gauge Blocks</b> . . . . .	<b>86</b>
<b>Rules, Precision</b> . . . . .	<b>66</b>
<b>Slide Calipers, Dial</b> . . . . .	<b>24</b>
<b>Slide Calipers, Electronic</b> . . . . .	<b>20</b>
<b>Slide Calipers, Vernier</b> . . . . .	<b>24</b>
<b>Squares, Combination</b> . . . . .	<b>60</b>
<b>Squares, Double</b> . . . . .	<b>64</b>
<b>Squares, Solid</b> . . . . .	<b>65</b>
<b>Testers, Hardness</b> . . . . .	<b>50</b>
<b>Testers, Surface Roughness</b> . . . . .	<b>55</b>
<b>Testers, Thickness</b> . . . . .	<b>54</b>



**Starrett®**

Precision, Quality, Innovation

# Starrett®

## The L. S Starrett Company

Oxnam Road

Jedburgh

Scotland

TD8 6LR

Tel: +44 (0) 1835 863501

Fax: +44 (0) 1835 863018

[sales@starrett.co.uk](mailto:sales@starrett.co.uk)

## How to Order

For prompt delivery, technical support and assistance, contact your nearest industrial distributor.

## Product Demonstration

All Starrett manufacturing and branch locations and many distributors can demonstrate an array of Starrett products at work. Contact your local distributor to learn more.

[www.starrett.co.uk](http://www.starrett.co.uk)

Product specifications and availability subject to change.

Catalogue 32E © The L.S. Starrett Company

11/11

