

# MULTIPLE PUMP XV-1

ø 50,8 - FLANGE "SAE AA"

**XV-1**

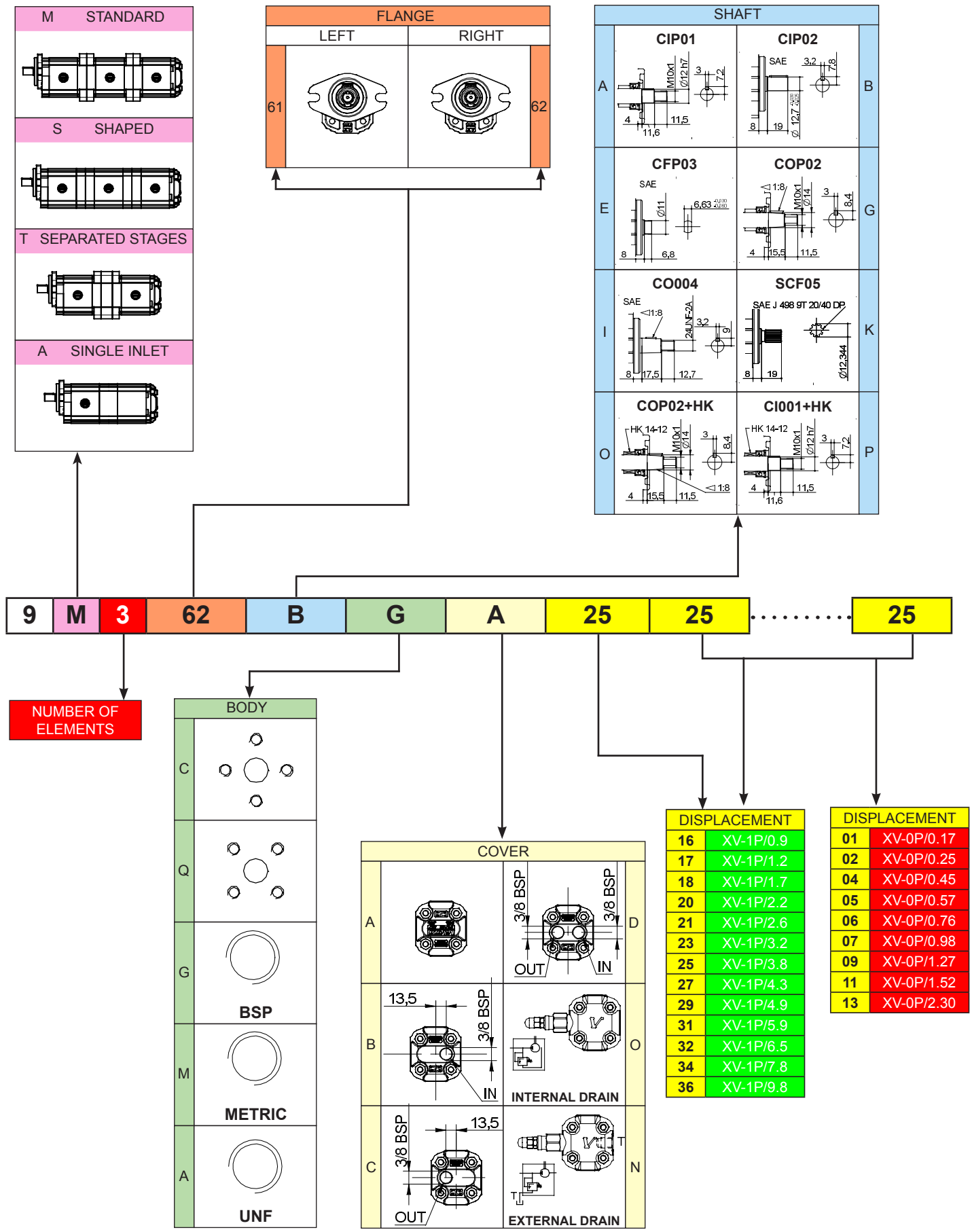

**MULTIPLE PUMP XV-1**  
**ø 50,8 - FLANGE "SAE AA"**

**XV-1**

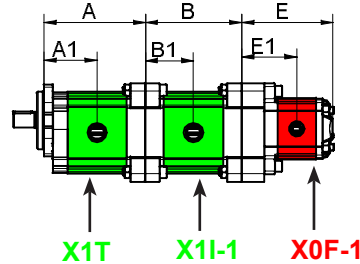
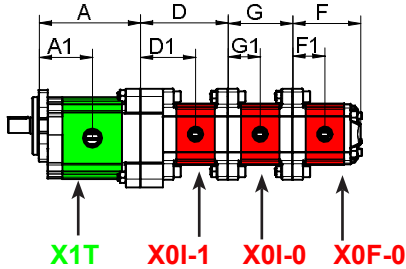
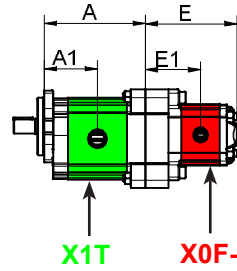
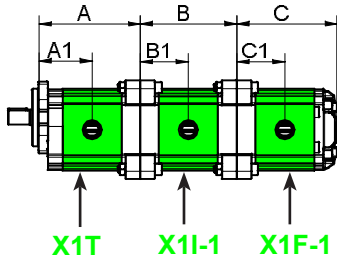
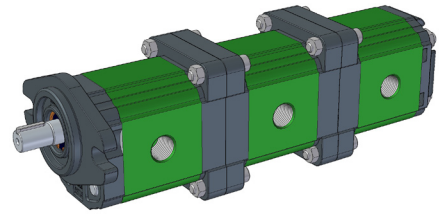
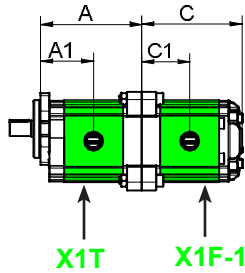
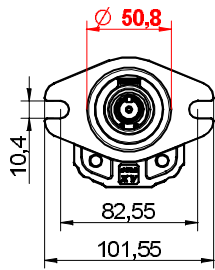

**SEPARATED STAGES**

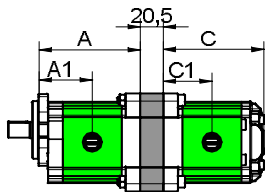

**SINGLE INLET**

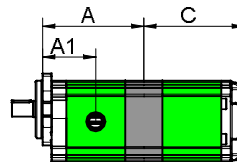

\* = SPECIAL ELEMENT, please contact our customer service for details.

TYPE	Displacement cc/rev	A mm	A1 mm	B mm	B1 mm	C mm	C1 mm	P1 bar	P3 bar	Min speed rpm	Max speed rpm
XV-1 / 0,9	0,91	79	41,8	74,5	37,3	78	37,3	240	280	700	6000
XV-1 / 1,2	1,17	80	42,3	75,5	37,8	79	37,8	250	290	700	6000
XV-1 / 1,7	1,56	81,5	43	77	38,5	80,5	38,5	250	290	700	6000
XV-1 / 2,2	2,08	83,5	44	79	39,5	82,5	39,5	250	290	700	6000
XV-1 / 2,6	2,60	85,5	45	81	40,5	84,5	40,5	250	300	700	6000
XV-1 / 3,2	3,12	87,5	46	83	41,5	86	41,5	250	300	700	6000
XV-1 / 3,8	3,64	89,5	47	85	42,5	88,5	42,5	250	300	700	6000
XV-1 / 4,3	4,26	91,5	48	87	43,5	90,5	43,5	250	300	700	6000
XV-1 / 4,9	4,94	94,5	49,5	90	45	93,5	45	250	300	700	6000
XV-1 / 5,9	5,85	98	51,3	93,5	46,8	97	46,8	250	300	700	5000
XV-1 / 6,5	6,50	100,5	52,5	96	48	99,5	48	250	300	700	5000
XV-1 / 7,8	7,54	104,5	54,5	100	50	103,5	50	220	260	700	5000
XV-1 / 9,8	9,88	113,5	59	109	54,5	112,5	54,5	190	230	700	4000

TYPE	Displacement cc/rev	D mm	D1 mm	E mm	E1 mm	F mm	F1 mm	G mm	G1 mm	P1 bar	P3 bar	Min speed rpm	Max speed rpm
XV-0 / 0,17	0,16	72,3	46,2	75,8	46,2	55,8	26,2	52,3	26,2	220	260	700	9000
XV-0 / 0,25	0,24	72,9	46,5	76,4	46,5	56,4	26,5	52,9	26,5	220	260	700	9000
XV-0 / 0,45	0,45	74,5	47,3	78	47,3	58	27,3	54,5	27,3	220	280	700	9000
XV-0 / 0,57	0,56	75,5	47,8	79	47,8	59	27,8	55,5	27,8	220	280	700	9000
XV-0 / 0,76	0,75	77	48,5	80,5	48,5	60,5	28,5	57	28,5	220	280	700	9000
XV-0 / 0,98	0,92	78,5	49,3	82	49,3	62	29,3	58,5	29,3	220	280	700	6000
XV-0 / 1,27	1,26	81	50,5	84,5	50,5	64,5	30,5	61	30,5	220	280	700	6000
XV-0 / 1,52	1,48	83	51,5	86,5	51,5	66,5	31,5	63	31,5	220	280	700	6000
XV-0 / 2,30	2,28	89	54,5	92,5	54,5	72,5	34,5	69	34,5	220	210	700	5000