

Type B3G Load Cell



Short description

- Stainless steel IP67 “S” type load cell
- Tension and compression applications
- Suitable for hanging, hopper and other weighing devices
- Also available in imperial capacities and dimensions



 test certificate no. D09-06.07
C of C no R60/2000-CNI-06.02

 Certificate no. 06-099A1

Available models

Capacity	Accuracy	Full article description
50kg	C3	B3G-C3-50kg-6B
100kg	C3	B3G-C3-100kg-6B
250kg	C3	B3G-C3-250kg-6B
500kg	C3	B3G-C3-500kg-6B
1t	C3	B3G-C3-1t-6B
2.5t	C3	B3G-C3-2.5t-6B
5t	C3	B3G-C3-5t-6B
7.5t	C3	B3G-C3-7.5t-6B
10t	C3	B3G-C3-10t-6B

Specifications and dimensions are subject to change without notice and do not constitute any liability whatsoever.

Type B3G Load Cell

Detailed specifications B3G

Accuracy class		OIML R60 C3			
Output sensitivity (= FS)	mV/V	3.0 ± 0.008			
Maximum capacity (E _{max})	t	0.05, 0.1	0.25, 0.5, 1, 2.5	5, 7.5, 10	
Max.number of load cell intervals	n _{LC}	3000			
Ratio of min. LC verification interval	$Y = E_{max} / v_{min}$	7000	10000	12000	
Combined Error	%FS	≤± 0.0200			
Minimum dead load	Of E _{max}	0%			
Safe overload	of E _{max}	150 %			
Ultimate overload	of E _{max}	300 %			
Zero balance	of FS	< ± 1.0 %			
Excitation, recommended voltage	V	5 ~ 12			
Excitation maximum	V	18			
Input resistance	Ω	430 ± 50			
Output resistance	Ω	351 ± 2			
Insulation resistance	MΩ	≥5000 (at 50VDC)			
Compensated temperature	°C	-10 ~ +40			
Operating temperature	°C	-35 ~ +65			
Storage temperature	°C	-40 ~ +70			
Element material		Stainless steel			
Ingress Protection (acc. to EN 60529)		IP67			
Recommended torque on fixation	Nm	M8:25	M12:75	M20:450	M24:750 M30:1450
ATEX classification (optional)		II1G Ex ia II1C T4	II1D Ex iaD 20 T73°C	II3G nL IIC T4	

Wiring

Wiring:

Shielded, 4 conductor cable.
 Cable diameter: Ø5mm
 Standard cable length: 6m
 Shield not connected to element

4-wire diagram

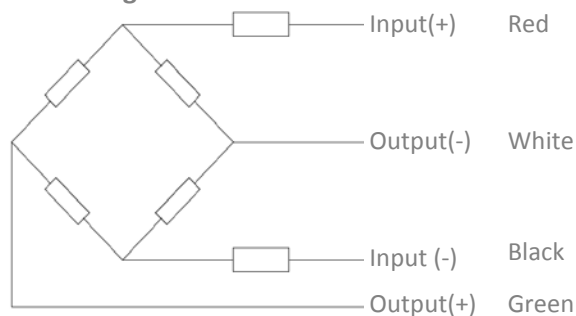

Specifications and dimensions are subject to change without notice and do not constitute any liability whatsoever.

Type B3G Load Cell

Dimensions in mm

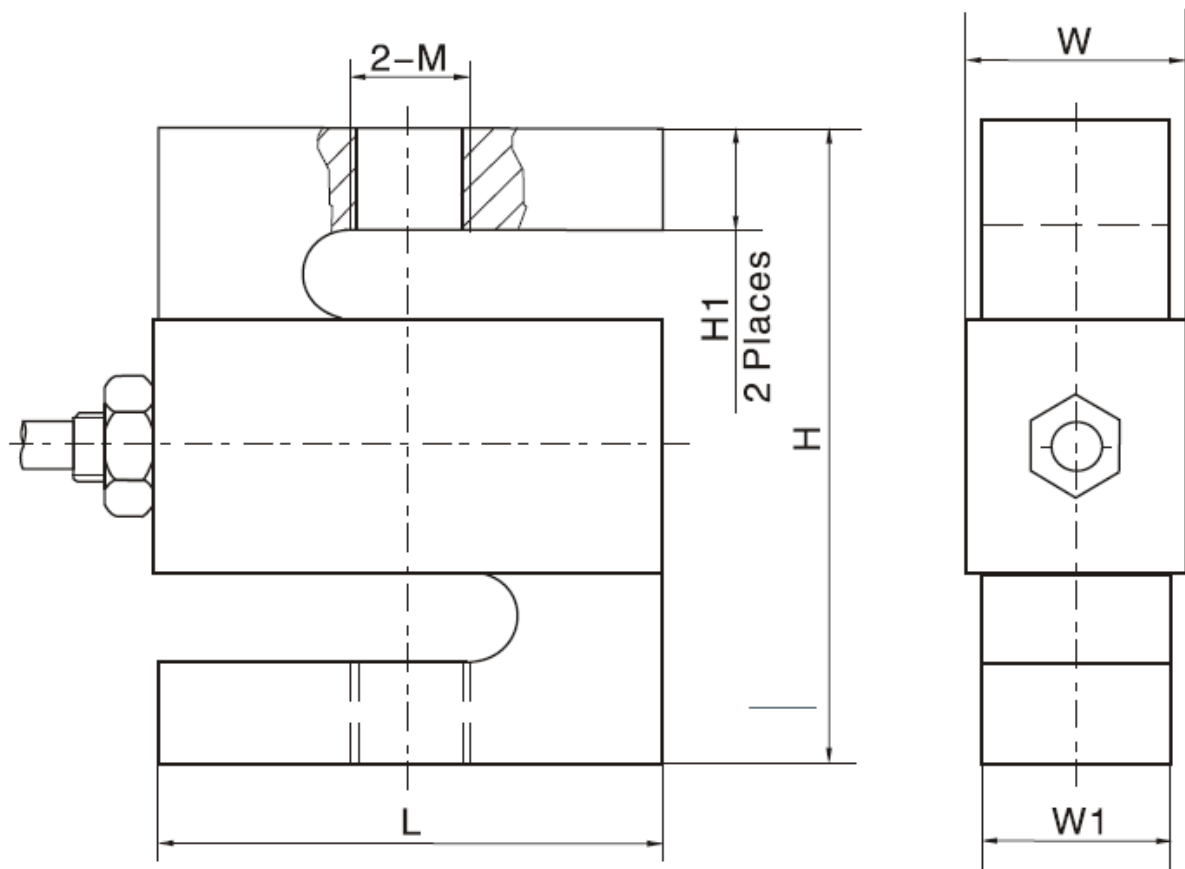

Dimension Capacity	L	H	H1	W1	W	M
50-100kg	50.8	60.96	8.89	11.68	15.06	M8
250-500kg	50.8	60.96	8.89	18.03	21.41	M12
1t	50.8	60.96	8.89	24.38	27.76	M12
2.5t	76.2	99.06	13.97	24.38	27.76	M20 x 1.5
5t	74.68	99.06	18.37	30.74	34.12	M20 x 1.5
7.5t	87.38	139.7	27.5	37.08	40.46	M24 x 2
10t	112.78	177.8	39.9	42.93	46.31	M30 x 2

Specifications and dimensions are subject to change without notice and do not constitute any liability whatsoever.

Type B3G Load Cell

Available accessories

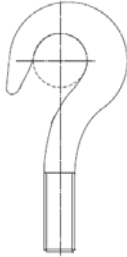
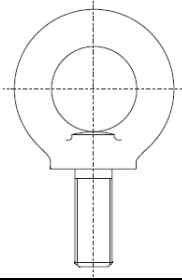
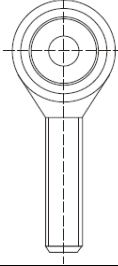
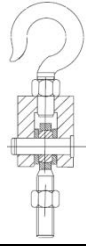
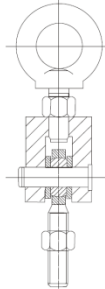
<p>HL-3-001-25kg-5t hook</p> <ul style="list-style-type: none">• Alloy Steel• Suitable for hybrid scales, crane scales, packaging scales and hopper scales	
<p>HL-3-002-25kg-5t eye</p> <ul style="list-style-type: none">• Alloy Steel• Suitable for hybrid scales, crane scales, packaging scales and hopper scales	
<p>HL-3-003-25kg-5t rod end</p> <ul style="list-style-type: none">• Alloy Steel• Suitable for hybrid scales, crane scales, packaging scales, hopper scales and other electronic weighing devices.	
<p>HL-3-004-25kg-5t hook assembly</p> <ul style="list-style-type: none">• Alloy Steel• Suitable for hybrid scales, crane scales, packaging scales, hopper scales and other electronic weighing devices.	
<p>HL-3-005-25kg-5t eye assembly</p> <ul style="list-style-type: none">• Alloy Steel• Suitable for hybrid scales, crane scales, packaging scales, hopper scales and other electronic weighing devices.	

Specifications and dimensions are subject to change without notice and do not constitute any liability whatsoever.